

# 2025

CATALOGUE



SOAP BUBBLES

PARTY BUBBLES

BUBBLE REFILL

BUBBLE TOYS

PLASTIC BUBBLES & MARBLES

FLOOR DISPLAYS



f @BubbleWorldToys 



The whole world  
in a bubble



# Sommario / Summary

<b>TEMI E PERSONAGGI / THEMES AND CHARACTERS</b> .....	5
<b>LA NOSTRA AZIENDA / OUR COMPANY</b> .....	8
<b>QUALITÀ E CERTIFICAZIONI / QUALITY AND CERTIFICATIONS</b> .....	9
<b>OBIETTIVI PER LO SVILUPPO SOSTENIBILE / SUSTAINABLE DEVELOPMENT GOALS</b> .....	10
<b>BOLLE DI SAPONE / SOAP BUBBLES</b>	
FORMATI / SIZES .....	16
STANDARD 60 ML DISPLAY .....	17
MAXI 175 ML DISPLAY .....	26
GLASS 300 ML DISPLAY .....	31
3-PACK .....	36
BLISTERCARD su richiesta / <i>On demand</i> .....	37
PACKS su richiesta / <i>On demand</i> .....	38
BOLLE PERSONALIZZABILI / CUSTOMIZABLE BUBBLES .....	39
<b>BOLLE PARTY / PARTY BUBBLES</b>	
PARTY BUBBLES .....	42
PARTY PACK 6 pcs. ....	42
MACCHINA BOLLE / BUBBLE MACHINE .....	43
<b>RICARICA BOLLE / BUBBLE REFILL</b>	
RICARICA BOLLE / BUBBLE REFILL .....	46
<b>GIOCABOLLE / BUBBLE TOYS</b>	
SPADA BOLLE / BUBBLE WAND .....	50
PISTOLE BOLLE / BUBBLE GUN .....	54
KIT BOLLE GIGANTI / GIANT BUBBLE KIT .....	63
FLYING DISC E BOLLE / FLYING DISC & BUBBLES .....	64
<b>BOLLE DI PLASTICA E PALLINE / PLASTIC BUBBLES &amp; MARBLES</b>	
BOLLE DI PLASTICA / PLASTIC BUBBLES .....	68
PALLINE DI PLASTICA / PLASTIC MARBLES ( <i>Cheecoting</i> ) .....	70
BIGLIE DI VETRO / GLASS MARBLES .....	71
<b>PALL-BOX / FLOOR DISPLAYS</b>	
PALL-BOX / FLOOR DISPLAYS .....	72

## LEGENDA SIMBOLI / SYMBOLS

 IN ESAURIMENTO STOCK DEPLETION	 GRAFICA IN AGGIORNAMENTO UNDER RESTYLING	 GRAFICA AGGIORNATA IN ARRIVO RESTYLING COMING SOON
---	---	---

Dulcop si riserva la facoltà di apportare modifiche tecniche ed estetiche ai prodotti di questo catalogo, senza alcun preavviso.  
*Dulcop reserves the right to make technical and aesthetic changes on the products of this catalogue, without prior notice.*



# AREE ETICHETTE LABEL AREAS

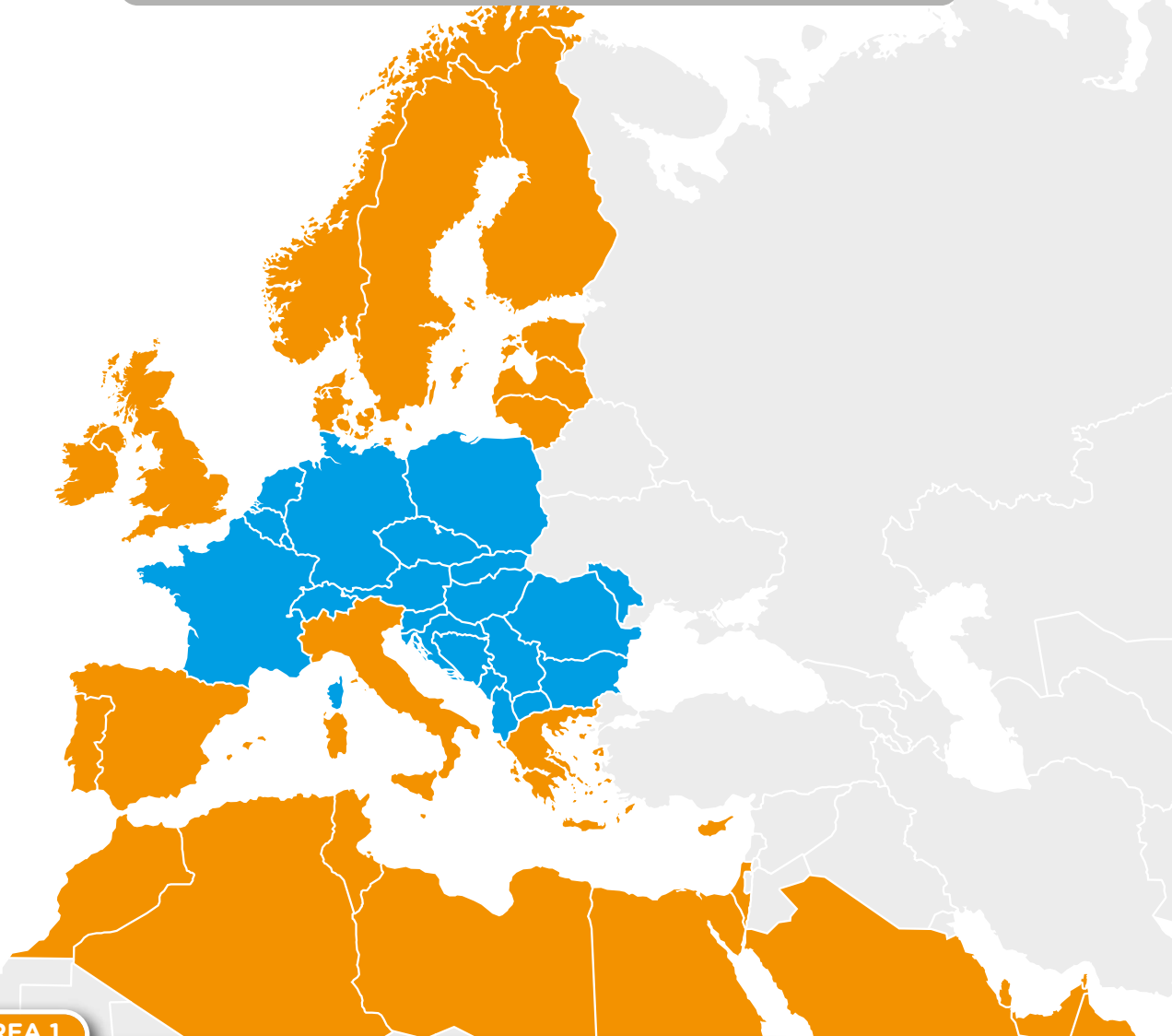

## AREA 1

 <b>DK</b> Denmark	 <b>GB</b> England	 <b>LT</b> Lithuania	 <b>PT</b> Portugal
 <b>EE</b> Estonia	 <b>GR</b> Greece	 <b>LV</b> Latvia	 <b>SA</b> Saudi Arabia
 <b>ES</b> Spain	 <b>IE</b> Ireland	 <b>MT</b> Malta	 <b>SE</b> Sweden
 <b>FI</b> Finland	 <b>IT</b> Italy	 <b>NO</b> Norway	

## AREA 2

 <b>AT</b> Austria	 <b>CZ</b> Czech Rep.	 <b>HU</b> Hungary	 <b>RO</b> Romania
 <b>BE</b> Belgium	 <b>DE</b> Germany	 <b>LU</b> Luxembourg	 <b>RS</b> Serbia
 <b>BG</b> Bulgaria	 <b>FR</b> France	 <b>NL</b> Netherlands	 <b>SI</b> Slovenia
 <b>CH</b> Switzerland	 <b>HR</b> Croatia	 <b>PL</b> Poland	 <b>SK</b> Slovakia

# Temi e personaggi - Themes and characters

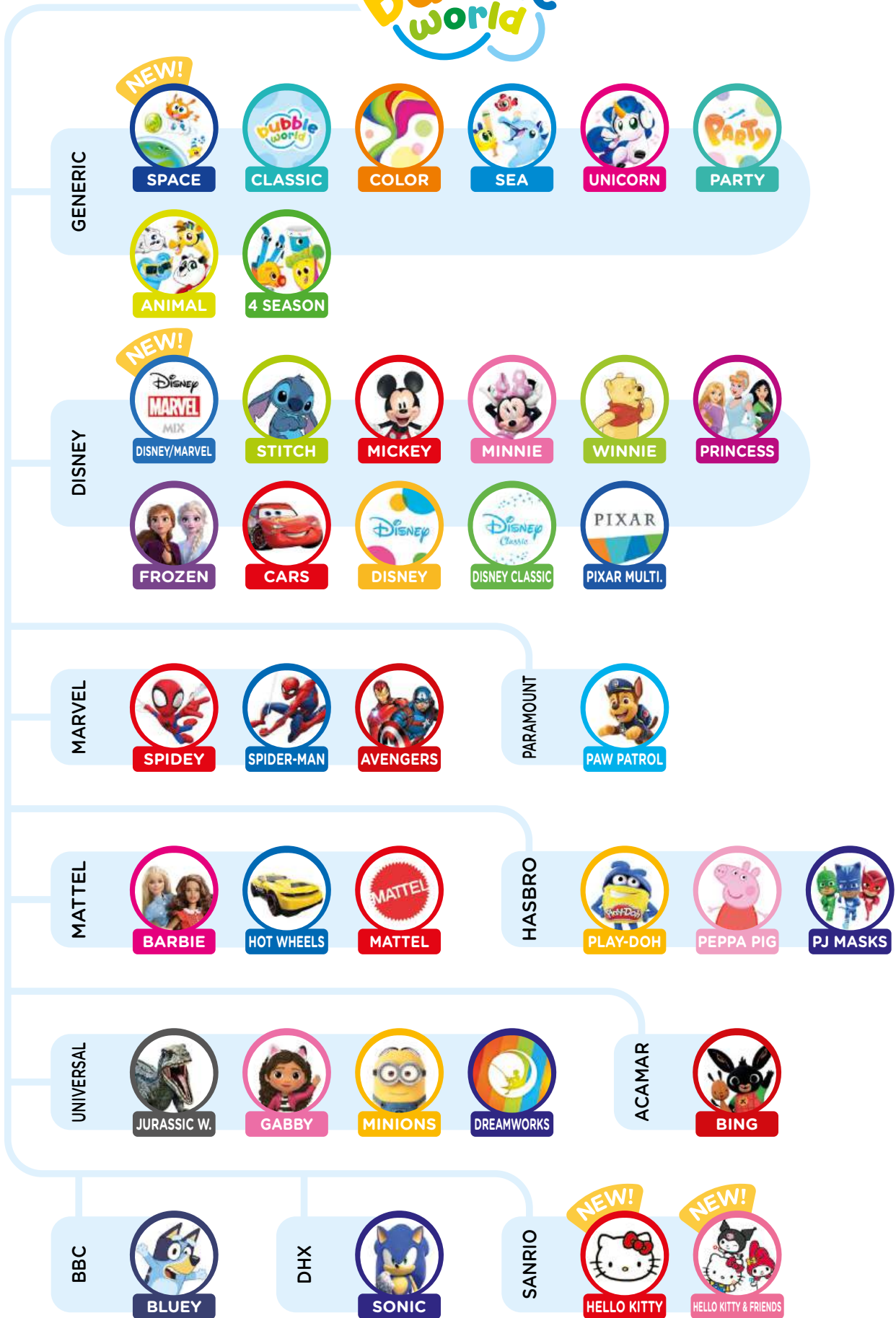



DISPONIBILE SU RICHIESTA (QUANTITÀ MINIMA NECESSARIA)  
AVAILABLE UPON REQUEST (MINIMUM ORDER QUANTITY REQUIRED)

DISNEY

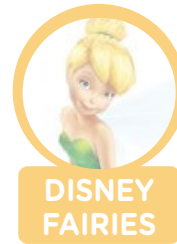

UNIVERSAL



HASBRO

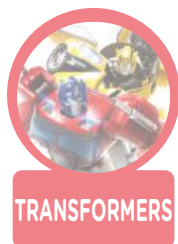

# CI SIAMO TRASFERITI! WE MOVED!



🚗 10 min  
7 km

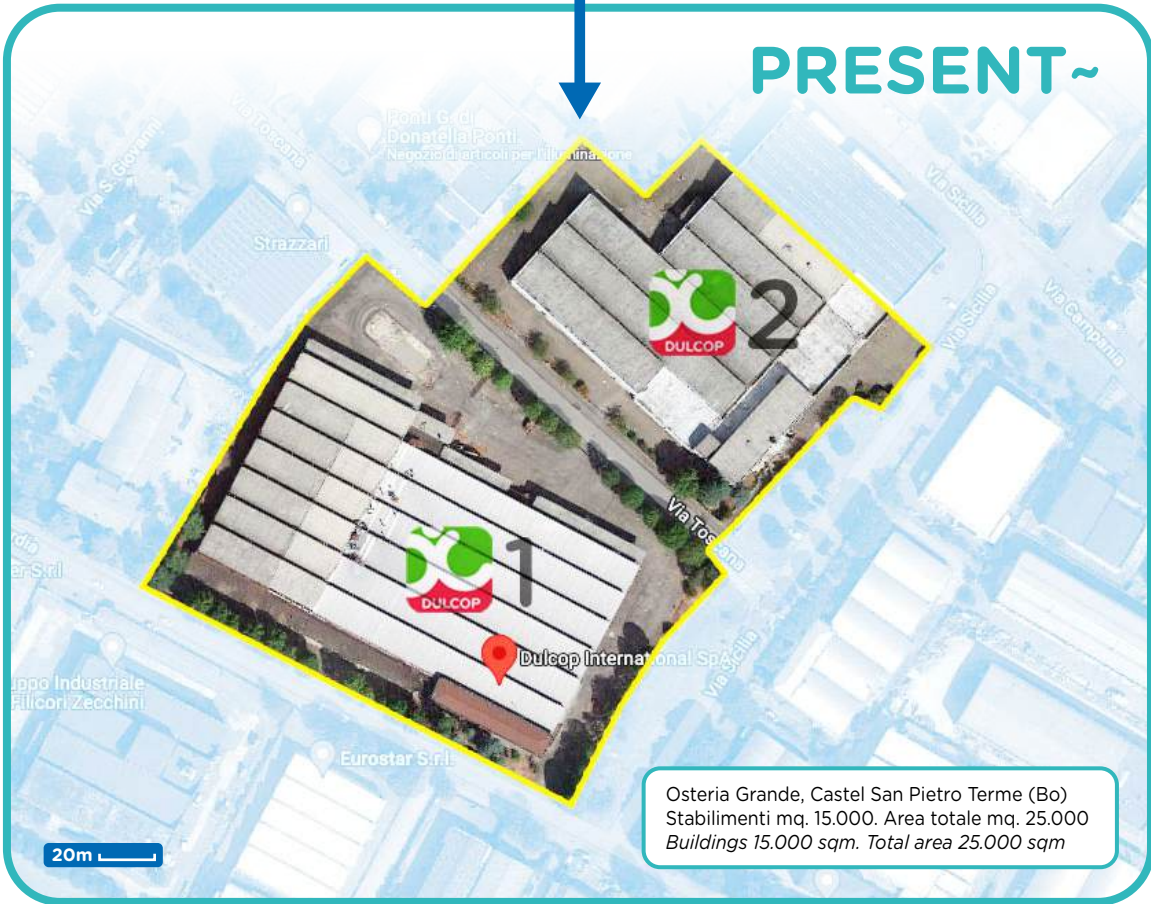

# La nostra azienda

## Our Company



### Chi siamo

Fondata nel 1938, Dulcop è la più grande azienda produttrice di bolle di sapone e Giocabolle™ in Europa con oltre 300 referenze di prodotti.

Il labirinto e la sfera sul tappo, inventato da Dulcop negli anni '70, sono il noto elemento distintivo delle nostre bolle di sapone in grado di offrire un doppio divertimento.

### Who we are

*Founded in 1938, with over 300 products, Dulcop is the largest manufacturer of soap bubbles and bubble toys in Europe.*

*The maze and plastic ball on the cap, created by Dulcop in the '70s, are the renowned distinctive marks of our soap bubbles, offering double fun.*



### Qualità

Produciamo in regime di qualità certificata ISO 9001:2015. Stampiamo il lotto di produzione su ogni flacone per garantirne la tracciabilità ed eseguiamo giornalmente quattro milioni di controlli automatizzati sul 100% della produzione.

Siamo l'unica azienda al mondo che ha introdotto il sigillo di garanzia sull'intera produzione di flaconi standard 60ml.

### Quality

*We produce under ISO 9001:2015. We print a batch number on each bottle to ensure all our products are traceable and we run four million automated quality controls daily on the total production.*

*We are the only manufacturer of soap bubbles to have introduced the safety sleeved seal on the entire production of standard 60ml bottles.*



### I nostri valori

Sempre pronti a migliorarci, garantiamo qualità e affidabilità dei nostri prodotti, trasparenza e passione nel rapporto con fornitori e clienti: perchè la capacità di costruire relazioni durature è il nostro valore aggiunto!

### Our values

*Always ready to better ourselves, we guarantee quality and reliability of our products, transparency and passion in the relationship with our suppliers and customers.*





# Qualità e Certificazioni

## Quality and Certifications

La qualità Dulcop è certificata. Dalla conformità dei processi produttivi alla sicurezza dei lavoratori, ogni operazione segue rigidi controlli che garantiscono ogni anno il rinnovo di importanti certificazioni riconosciute da enti nazionali e internazionali.

*Dulcop quality is certified. From the compliance of production processes to the safety of workers, each operation follows strict standards and controls that guarantee every year the renewal of important certifications recognized by national and international bodies.*



Sistema di gestione della qualità certificato.  
*Certified quality management system.*



ID: 380-000002-00

Codice di comportamento amfori BSCI per i diritti etici del lavoro e tutela dell'ambiente.  
*Code of conduct for the ethical rights of workers and the protection of the environment.*



Non testato su animali.  
*Not tested on animals.*



Classification, Labeling & Packaging Regolamento per la sicurezza del liquido.  
*Regulation for the safety of the bubble solution.*



Certificazione (su richiesta) per la sicurezza del liquido sulla pelle.  
*Certification (upon request) for the safety of the bubble solution on the skin.*



G-mark

Certificazione per le normative del giocattolo nei paesi del Golfo.  
*Certification for the toy technical regulations of the Gulf Countries.*



Certificazione per la sicurezza del giocattolo.  
*Certification for the toy safety.*



Produzione in economia circolare per un uso efficiente delle risorse e ridurre l'impatto ambientale.  
*Circular economy production for efficient use of resources and reduce environmental impact.*



Riempibile e riutilizzabile.  
*Refillable and reusable.*



Carta e cartone realizzati con materie prime derivanti da foreste correttamente gestite (FSC).  
*Paper and card board packaging made of materials derived from sustainable forests (FSC).*



Liquido senza parabeni.  
*Paraben free solution.*



Meno plastica nei nostri flaconi.  
*Less plastics in our bottles.*



Soluzione certificata priva di glutine.  
*Solution gluten-free certified.*



Eccellenza italiana, stile e impegno per prodotti di alta qualità.  
*Italian excellence, style and commitment for high quality products.*

- Processo produttivo a circuito chiuso con minima percentuale di scarto
- Produzione monocolor bianco per tubetto standard 60ml
- Riduzione plastica nei nostri flaconi del 16%
- Uso di carta e cartone certificati FSC
- Digitalizzazione dei processi di lavoro e riduzione del 90% dell'uso di carta
- Riduzione consumo di plastica monouso
- Adesione al codice di condotta AMFORI BSCI
- Impegno di filiera etica ed ecosostenibile condiviso con i fornitori
- Valutazione formula liquido bolle di sapone conforme ai principi Allergy Certify
- Acquisto nuovo stabilimento

## 2016-2021



## 2022



- Produzione monomateriale del tubetto standard 60ml
- Utilizzo 30% plastica riciclata nei flaconi
- Avviamento pratiche Industria 4.0 per la transizione digitale e tecnologica
- Aggiornamento codice di condotta etico aziendale in approccio due diligence
- Ottenimento del PRS Green Label per la promozione dello scambio pallet o il noleggio al posto dell'acquisto

- Trasferimento e ristrutturazione nuova sede operativa aziendale con riguardo verso un miglior efficientamento energetico e autoproduzione di energia elettrica
- Acquisto di energia da fonti rinnovabili
- Innalzamento al 60% della percentuale di lavoratrici donne impiegate nei reparti produttivi e negli uffici all'interno dell'azienda
- Installazione nuovo sistema software e gestionale che permette l'automatizzazione di molti processi aziendali
- Formulazione liquido senza profumo per una migliorata ipoallergenicità

## 2023



- Completamento del trasferimento della nuova sede operativa
- Installazione fotovoltaico
- Maggiori spazi verdi in azienda con aree dedicate ai dipendenti per un aumentato benessere aziendale
- Efficientamento energetico: utilizzo di pompe di calore per il riscaldamento e il raffreddamento delle aree produttive e logistiche senza l'ausilio di gas e installazione di sistemi di ventilazione meccanica controllata all'interno degli uffici e delle aree comuni

## 2024



- Adesione al programma UL per monitoraggio emissioni di carbonio
- Certificazione ISO 14001: Sistema di gestione ambientale
- Certificazione 50001: Strategie di gestione per l'efficienza energetica
- Certificazione 45001: Gestione della salute e della sicurezza sul lavoro
- Certificazione 14064: Gestione delle politiche ambientali di Carbon Management (GHG)

## 2025-2026



- Implementazione del sistema produttivo e riduzione dei turni di lavoro notturni per garantire migliori condizioni di lavoro
- Produzione giocabolle in Italia per maggiore controllo qualitativo e riduzione CO2 immessa in atmosfera
- Parità di genere: sviluppo di un ambiente di lavoro inclusivo
- Certificazione 27001: sistema di sicurezza delle informazioni

## 2027-2028



- Realizzazione di un sistema produttivo che riduca ulteriormente i costi energetici e preveda un ciclo produttivo più efficiente, con un minor tempo ciclo e una diminuzione dell'impiego di carta e plastica
- LCA: life cycle assessment: valutazione del ciclo di vita di un prodotto lungo tutte le sue fasi (impatto ambientale)

## 2029-2030



- Closed-circuit production with minimum waste percentage
- White monochrome production for the 60ml standard bottle
- Production of soap bubble bottles by using 16% less plastic
- Use of FSC certified paper and cardboard
- Digitalization of work processes and reduction of paper consumption by 90%
- Reduction of disposable plastic consumption
- Compliance to the AMFORI BSCI Code of Conduct
- Commitment to an ethical and eco-friendly production chain shared with our suppliers
- Compliance of our bubble solution formula with the Allergy Certify principles
- Purchase of new production facility

## 2016-2021



## 2022



- Mono-material production of our standard 60ml bottle
- Use of 30% recycled plastic in our bottles
- Participation to Industria 4.0 Italian National Plan for the digital and technological transition
- Update of the company's ethical Code of Conduct in due diligence approach
- Achievement of PRS Green Label for the incentivization of pallet exchange and rent instead of purchase

- Transfer to and renovation of new operational headquarters, with special consideration to energy efficiency and energy self-production
- Energy purchase from renewable sources
- Increase to 60% of the percentage of female workers employed in production departments and offices within the company
- Upgrade to a new management software system which allows the automatization of many company's processes
- Perfume-free formula of our bubble solution for an improved hypoallergenicity

## 2023



- Completion of the new manufacturing site and logistics hub
- Installation of photovoltaic system (9.000 square metres)
- New green areas in the company for enhanced organisational wellbeing
- Energy efficiency: use of heat pumps for heating and cooling production and logistics areas without the use of fossil fuels. Installation of controlled mechanical ventilation systems in the offices and in the common areas

## 2024



- Participation to the UL program for carbon footprint monitoring
- Achievement of ISO 14001 certification: Environmental management system
- Achievement of 50001 certification: Management strategies for energy efficiency
- Achievement of 45001 certification: Management of health and safety at work
- Achievement of ISO 14064 certification: Carbon Management - control and manage of the greenhouse gas emission (GHG)

## 2025-2026



- Implementation of the production system and reduction of night shifts to ensure better working conditions
- Production of bubble toys in Italy for higher quality control and reduction of CO2
- Gender equality: developing an inclusive work environment
- Achievement of 27001 certification: information security management system

## 2027-2028



- Implementation of a production system that further reduces energy costs and enables a more efficient production cycle, with less time per cycle and less use of paper and plastic
- LCA: life cycle assessment: evaluation of the life cycle of a product along its phases (environmental impact)

## 2029-2030



# SPACE



# Disney / MARVEL

MIX



# HELLO KITTY



# HELLO KITTY AND FRIENDS



# Disney Stitch



# BLUEY



# UNICORN



# SEA



# ANIMAL





[@BubbleWorldToys](#)



# Bolle di sapone

## *Soap bubbles*



FORMATI - SIZES

**STANDARD**

60 ml  
2,1 fl oz UK

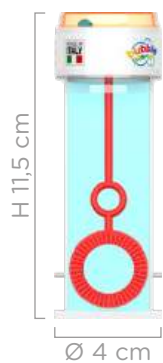

**MAXI**

175 ml  
6,1 fl oz UK

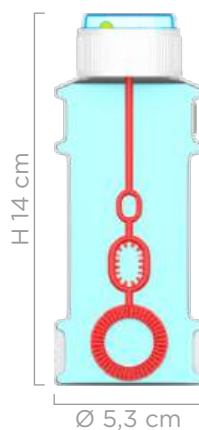

**GLASS**

300 ml  
10,5 fl oz UK

Flacone trasparente  
Transparent bottle

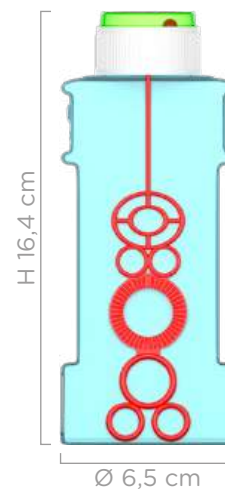

**REFILL 0.5**

0,5 L  
17,5 fl oz UK

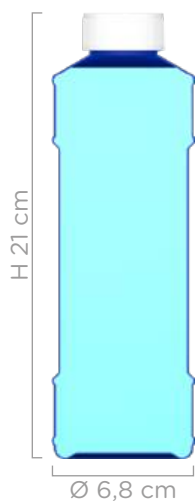

**REFILL 1.0**

1 L  
35,1 fl oz UK

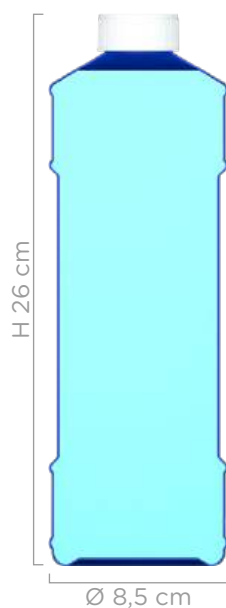

**REFILL 3.0**

3 L  
0,66 gal UK



**REFILL 5.0**

5 L  
1,09 gal UK

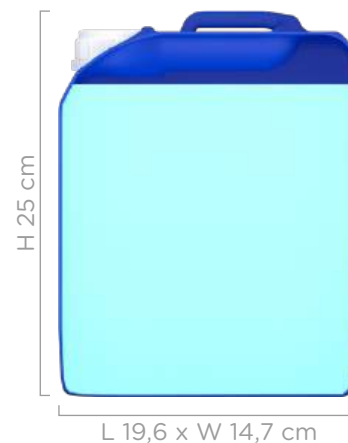



# Bolle di sapone Soap bubbles



**STANDARD - display**  
60 ml - 2,1 fl oz UK

SOAP BUBBLES

## Safety commitment



Sigillo di sicurezza sul tappo.

*Sleeved seal on the top.*

Gluten Free.  
Hypoallergenic.  
Paraben Free.

Lotto di produzione impresso sulla flacone.

*Batch of production printed on the bottle.*

Liquido 100% microbiologicamente testato.

*100% microbiologically tested solution.*

La forma dei flaconi è un marchio 3D registrato.

*The bottle shape is registered as 3D trade mark.*



## Environmental commitment



Riempibile e riutilizzabile.  
*Refillable and reusable.*



Flacone, tappo, soffiatore, vetrino e pallina in mono materiale.

*Mono-material bottle, cap, blower, lid and ball.*

Componenti prodotto interamente riciclabili.

*Product components fully recyclable.*

## Playability commitment

Soffiatore inserito nel tappo.

*Built-in wand.*

Gioco sul tappo.  
*Game on the top.*

Testato per resistere alle diverse condizioni climatiche.  
*Tested to withstand different climatic conditions.*

Pallina di plastica (non si ossida).

*Plastic ball (does not oxidize).*



DAT TECNICI - TECHNICAL DATA

### display

36 pz / pcs  
cm 23,5 x 23,5 x 12

### cartone / carton

6 displays  
216 pz / pcs  
cm 25 x 48,7 x 37  
kg 17,4

epal pallet cm 80 x 120

30 ct / cts

**NEW!**

**Space Bubbles**

PRODUCT



**AREA 1**

DK EE ES FI GB  
GR IE IT LT LV MT  
NO PT SA SE

**103001010048**

**AREA 2**

AT BE BG CH CZ  
DE FR HR HU LU NL  
PL RO RS SI SK

**103001310048**

**Classic Bubbles**

PRODUCT



**AREA 1**

DK EE ES FI GB  
GR IE IT LT LV MT  
NO PT SA SE

**103001010001**

**AREA 2**

AT BE BG CH CZ  
DE FR HR HU LU NL  
PL RO RS SI SK

**103001310001**

**Color Bubbles**

PRODUCT



**AREA 1**

DK EE ES FI GB  
GR IE IT LT LV MT  
NO PT SA SE

**103001010002**

**AREA 2**

AT BE BG CH CZ  
DE FR HR HU LU NL  
PL RO RS SI SK

**103001310002**

**Sea Bubbles**

PRODUCT



**AREA 1**

DK EE ES FI GB  
GR IE IT LT LV MT  
NO PT SA SE

**103001010003**

**AREA 2**

AT BE BG CH CZ  
DE FR HR HU LU NL  
PL RO RS SI SK

**103001310003**

**Unicorn Bubbles**

PRODUCT



**AREA 1**

DK EE ES FI GB  
GR IE IT LT LV MT  
NO PT SA SE

**103001010004**

**AREA 2**

AT BE BG CH CZ  
DE FR HR HU LU NL  
PL RO RS SI SK

**103001310004**

### Party Bubbles

PRODUCT



8 007315 438001

DISPLAY



8 007315 043809



#### AREA 1

DK EE ES FI GB  
GR IE IT LT LV MT  
NO PT SA SE

103001010006

#### AREA 2

AT BE BG CH CZ  
DE FR HR HU LU NL  
PL RO RS SI SK

103001310006

### Animal Bubbles

PRODUCT



8 007315 828000

DISPLAY



8 007315 082808



#### AREA 1

DK EE ES FI GB  
GR IE IT LT LV MT  
NO PT SA SE

103001010005

#### AREA 2

AT BE BG CH CZ  
DE FR HR HU LU NL  
PL RO RS SI SK

103001310005

### Four Seasons Bubbles

PRODUCT



8 007315 843003

DISPLAY



8 007315 084307



#### AREA 1

DK EE ES FI GB  
GR IE IT LT LV MT  
NO PT SA SE

103001010007

#### AREA 2

AT BE BG CH CZ  
DE FR HR HU LU NL  
PL RO RS SI SK

103001310007

### NEW!

### Disney/Marvel Mix Bubbles

PRODUCT



8 007315 008792

DISPLAY



8 007315 008785



#### AREA 1

DK EE ES FI GB  
GR IE IT LT LV MT  
NO PT SA SE

103001010049

#### AREA 2

AT BE BG CH CZ  
DE FR HR HU LU NL  
PL RO RS SI SK

103001310049

### Stitch Bubbles

PRODUCT



8 007315 007931

DISPLAY



8 007315 007948



#### AREA 1

DK EE ES FI GB  
GR IE IT LT LV MT  
NO PT SA SE

103001010043

#### AREA 2

AT BE BG CH CZ  
DE FR HR HU LU NL  
PL RO RS SI SK

103001310043

**Princess/Avengers  
Bubbles**

PRODUCT  
8 007315 885102

DISPLAY  
8 007315 088510



**AREA 1**

DK EE ES FI GB  
GR IE IT LT LV MT  
NO PT SA SE

**103001010037**

**AREA 2**

AT BE BG CH CZ  
DE FR HR HU LU NL  
PL RO RS SI SK

**103001310037**

**Mickey  
Bubbles**

PRODUCT  
8 007315 410021

DISPLAY  
8 007315 041201



**AREA 1**

DK EE ES FI GB  
GR IE IT LT LV MT  
NO PT SA SE

**103001010010**

**AREA 2**

AT BE BG CH CZ  
DE FR HR HU LU NL  
PL RO RS SI SK

**103001310010**

**Minnie  
Bubbles**

PRODUCT  
8 007315 538008

DISPLAY  
8 007315 053808



**AREA 1**

DK EE ES FI GB  
GR IE IT LT LV MT  
NO PT SA SE

**103001010011**

**AREA 2**

AT BE BG CH CZ  
DE FR HR HU LU NL  
PL RO RS SI SK

**103001310011**

**Winnie the Pooh  
Bubbles**

PRODUCT  
8 007315 442206

DISPLAY  
8 007315 044226



**AREA 1**

DK EE ES FI GB  
GR IE IT LT LV MT  
NO PT SA SE

**103001010015**

**AREA 2**

AT BE BG CH CZ  
DE FR HR HU LU NL  
PL RO RS SI SK

**103001310015**

**Princess  
Bubbles**

PRODUCT  
8 007315 448000

DISPLAY  
8 007315 044806



**AREA 1**

DK EE ES FI GB  
GR IE IT LT LV MT  
NO PT SA SE

**103001010012**

**AREA 2**

AT BE BG CH CZ  
DE FR HR HU LU NL  
PL RO RS SI SK

**103001310012**

### Frozen Bubbles

PRODUCT



8 007315 823005

DISPLAY



8 007315 082303



#### AREA 1

DK EE ES FI GB  
GR IE IT LT LV MT  
NO PT SA SE

103001010013

#### AREA 2

AT BE BG CH CZ  
DE FR HR HU LU NL  
PL RO RS SI SK

103001310013

### Cars Bubbles

PRODUCT



8 007315 490009

DISPLAY



8 007315 049009



#### AREA 1

DK EE ES FI GB  
GR IE IT LT LV MT  
NO PT SA SE

103001010014

#### AREA 2

AT BE BG CH CZ  
DE FR HR HU LU NL  
PL RO RS SI SK

103001310014

### Disney Multi P. Bubbles

PRODUCT



8 007315 820004

DISPLAY



8 007315 282000



#### AREA 1

DK EE ES FI GB  
GR IE IT LT LV MT  
NO PT SA SE

103001010018

#### AREA 2

AT BE BG CH CZ  
DE FR HR HU LU NL  
PL RO RS SI SK

103001310018

### Disney Classic Bubbles

PRODUCT



8 007315 842501

DISPLAY



8 007315 084253



#### AREA 1

DK EE ES FI GB  
GR IE IT LT LV MT  
NO PT SA SE

103001010019

#### AREA 2

AT BE BG CH CZ  
DE FR HR HU LU NL  
PL RO RS SI SK

103001310019

### Pixar Multi P. Bubbles

PRODUCT



8 007315 840002

DISPLAY



8 007315 084000



#### AREA 1

DK EE ES FI GB  
GR IE IT LT LV MT  
NO PT SA SE

103001010020

#### AREA 2

AT BE BG CH CZ  
DE FR HR HU LU NL  
PL RO RS SI SK

103001310020

### Spidey & Friends Bubbles

PRODUCT



DISPLAY



**AREA 1**

DK EE ES FI GB  
GR IE IT LT LV MT  
NO PT SA SE

**103001010046**

**AREA 2**

AT BE BG CH CZ  
DE FR HR HU LU NL  
PL RO RS SI SK

**103001310046**

### Spider-Man Bubbles

PRODUCT



DISPLAY



**AREA 1**

DK EE ES FI GB  
GR IE IT LT LV MT  
NO PT SA SE

**103001010009**

**AREA 2**

AT BE BG CH CZ  
DE FR HR HU LU NL  
PL RO RS SI SK

**103001310009**

### Avengers Bubbles

PRODUCT



DISPLAY



**AREA 1**

DK EE ES FI GB  
GR IE IT LT LV MT  
NO PT SA SE

**103001010017**

**AREA 2**

AT BE BG CH CZ  
DE FR HR HU LU NL  
PL RO RS SI SK

**103001310017**

### PAW Patrol Bubbles

PRODUCT



DISPLAY



**AREA 1**

DK EE ES FI GB  
GR IE IT LT LV MT  
NO PT SA SE

**103001010025**

**AREA 2**

AT BE BG CH CZ  
DE FR HR HU LU NL  
PL RO RS SI SK

**103001310025**

### Mattel Multi P. Bubbles

PRODUCT



DISPLAY



**AREA 1**

DK EE ES FI GB  
GR IE IT LT LV MT  
NO PT SA SE

**103001010038**

**AREA 2**

AT BE BG CH CZ  
DE FR HR HU LU NL  
PL RO RS SI SK

**103001310038**

**Barbie**  
Bubbles

PRODUCT



8 007315 550000

DISPLAY



8 007315 155007



**AREA 1**

DK EE ES FI GB  
GR IE IT LT LV MT  
NO PT SA SE

103001010021

**AREA 2**

AT BE BG CH CZ  
DE FR HR HU LU NL  
PL RO RS SI SK

103001310021

**Hot Wheels**  
Bubbles

PRODUCT



8 007315 802505

DISPLAY



8 007315 080255



**AREA 1**

DK EE ES FI GB  
GR IE IT LT LV MT  
NO PT SA SE

103001010022

**AREA 2**

AT BE BG CH CZ  
DE FR HR HU LU NL  
PL RO RS SI SK

103001310022

**Plah-Doh**  
Bubbles

PRODUCT



8 007315 847506

DISPLAY



8 007315 084758



**AREA 1**

DK EE ES FI GB  
GR IE IT LT LV MT  
NO PT SA SE

103001010034

**AREA 2**

AT BE BG CH CZ  
DE FR HR HU LU NL  
PL RO RS SI SK

103001310034

**Peppa Pig**  
Bubbles

PRODUCT



8 007315 597005

DISPLAY



8 007315 159708



**AREA 1**

DK EE ES FI GB  
GR IE IT LT LV MT  
NO PT SA SE

103001010023

**AREA 2**

AT BE BG CH CZ  
DE FR HR HU LU NL  
PL RO RS SI SK

103001310023

**PJ Masks**  
Bubbles

PRODUCT



8 007315 697002

DISPLAY



8 007315 069700



**AREA 1**

DK EE ES FI GB  
GR IE IT LT LV MT  
NO PT SA SE

103001010027

**AREA 2**

AT BE BG CH CZ  
DE FR HR HU LU NL  
PL RO RS SI SK

103001310027

### Jurassic World Bubbles

PRODUCT  
8 007315 848008

DISPLAY  
8 007315 084802



**AREA 1**

DK EE ES FI GB  
GR IE IT LT LV MT  
NO PT SA SE

**103001010033**

**AREA 2**

AT BE BG CH CZ  
DE FR HR HU LU NL  
PL RO RS SI SK

**103001310033**

### Gabby's Dollhouse Bubbles

PRODUCT  
8 007315 008013

DISPLAY  
8 007315 008020



**AREA 1**

DK EE ES FI GB  
GR IE IT LT LV MT  
NO PT SA SE

**103001010045**

**AREA 2**

AT BE BG CH CZ  
DE FR HR HU LU NL  
PL RO RS SI SK

**103001310045**

### Minions Bubbles

PRODUCT  
8 007315 611008

DISPLAY  
8 007315 061100



**AREA 1**

DK EE ES FI GB  
GR IE IT LT LV MT  
NO PT SA SE

**103001010028**

**AREA 2**

AT BE BG CH CZ  
DE FR HR HU LU NL  
PL RO RS SI SK

**103001310028**

### Dreamworks Multi P. Bubbles

PRODUCT  
8 007315 843508

DISPLAY  
8 007315 084352



**AREA 1**

DK EE ES FI GB  
GR IE IT LT LV MT  
NO PT SA SE

**103001010030**

**AREA 2**

AT BE BG CH CZ  
DE FR HR HU LU NL  
PL RO RS SI SK

**103001310030**

### Bing Bubbles

PRODUCT  
8 007315 819008

DISPLAY  
8 007315 081900



**AREA 1**

DK EE ES FI GB  
GR IE IT LT LV MT  
NO PT SA SE

**103001010031**

**AREA 2**

AT BE BG CH CZ  
DE FR HR HU LU NL  
PL RO RS SI SK

**103001310031**



### Bluey Bubbles

PRODUCT



DISPLAY



**AREA 1**

DK EE ES FI GB  
GR IE IT LT LV MT  
NO PT SA SE

103001010036

**AREA 2**

AT BE BG CH CZ  
DE FR HR HU LU NL  
PL RO RS SI SK

103001310036

### Sonic Bubbles

PRODUCT



DISPLAY



**AREA 1**

DK EE ES FI GB  
GR IE IT LT LV MT  
NO PT SA SE

103001010044

**AREA 2**

AT BE BG CH CZ  
DE FR HR HU LU NL  
PL RO RS SI SK

103001310044

**NEW!**

### Hello Kitty Bubbles

PRODUCT



DISPLAY



**AREA 1**

DK EE ES FI GB  
GR IE IT LT LV MT  
NO PT SA SE

103001010051

**AREA 2**

AT BE BG CH CZ  
DE FR HR HU LU NL  
PL RO RS SI SK

103001310051

**NEW!**

### Hello Kitty & Friends Bubbles

PRODUCT



DISPLAY



**AREA 1**

DK EE ES FI GB  
GR IE IT LT LV MT  
NO PT SA SE

103001010052

**AREA 2**

AT BE BG CH CZ  
DE FR HR HU LU NL  
PL RO RS SI SK

103001310052

# Bolle di sapone

## Soap bubbles



# MAXI - display

175 ml - 6,1 fl oz UK

### Safety commitment



Gluten Free.  
Hypoallergenic.  
Paraben Free.

Lotto di produzione  
impresso sulla flacone.

*Batch of production  
printed on the bottle.*

Liquido 100%  
microbiologicamente  
testato.

*100% microbiologically  
tested solution.*



### Environmental commitment



Riempibile e  
riutilizzabile.

*Refillable and  
reusable.*



Componenti prodotto  
interamente riciclabili.

*Product components  
fully recyclable.*

### Playability commitment

Soffiatore inserito  
nel tappo.

*Built-in wand.*

Gioco sul tappo.

*Game on the top.*

Testato per resistere alle  
diverse condizioni  
climatiche.

*Tested to withstand  
different climatic conditions.*

Pallina di plastica  
(non si ossida).

*Plastic ball  
(does not oxidize).*



DAT TECNICI - TECHNICAL DATA

#### display

16 pz / pcs  
cm 23,5 x 23,5 x 14,8  
kg 3,3

epal pallet cm 80 x 120

10x15 display

**Classic  
Maxi Bubbles**



**AREA 1**

DK EE ES FI GB GR IE IT LT  
LV MT NO PT SA SE

**113002010001**

**AREA 2**

AT BE BG CH CZ DE FR HR  
HU LU NL PL RO RS SI SK

**113002310001**

**Color  
Maxi Bubbles**



**AREA 1**

DK EE ES FI GB GR IE IT LT  
LV MT NO PT SA SE

**113002010002**

**AREA 2**

AT BE BG CH CZ DE FR HR  
HU LU NL PL RO RS SI SK

**113002310002**

**Unicorn  
Maxi Bubbles**



**AREA 1**

DK EE ES FI GB GR IE IT LT  
LV MT NO PT SA SE

**113002010004**

**AREA 2**

AT BE BG CH CZ DE FR HR  
HU LU NL PL RO RS SI SK

**113002310004**

**Animal  
Maxi Bubbles**



**AREA 1**

DK EE ES FI GB GR IE IT LT  
LV MT NO PT SA SE

**113002010005**

**AREA 2**

AT BE BG CH CZ DE FR HR  
HU LU NL PL RO RS SI SK

**113002310005**

**Stitch  
Maxi Bubbles**



**AREA 1**

DK EE ES FI GB GR IE IT LT  
LV MT NO PT SA SE

**113002010043**

**AREA 2**

AT BE BG CH CZ DE FR HR  
HU LU NL PL RO RS SI SK

**113002310043**

### Mickey Maxi Bubbles

PRODUCT



DISPLAY



#### AREA 1

DK EE ES FI GB GR IE IT LT  
LV MT NO PT SA SE

113002010010

#### AREA 2

AT BE BG CH CZ DE FR HR  
HU LU NL PL RO RS SI SK

113002310010

### Minnie Maxi Bubbles

PRODUCT



DISPLAY



#### AREA 1

DK EE ES FI GB GR IE IT LT  
LV MT NO PT SA SE

113002010011

#### AREA 2

AT BE BG CH CZ DE FR HR  
HU LU NL PL RO RS SI SK

113002310011

### Princess Maxi Bubbles

PRODUCT



DISPLAY



#### AREA 1

DK EE ES FI GB GR IE IT LT  
LV MT NO PT SA SE

113002010012

#### AREA 2

AT BE BG CH CZ DE FR HR  
HU LU NL PL RO RS SI SK

113002310012

### Frozen Maxi Bubbles

PRODUCT



DISPLAY



#### AREA 1

DK EE ES FI GB GR IE IT LT  
LV MT NO PT SA SE

113002010013

#### AREA 2

AT BE BG CH CZ DE FR HR  
HU LU NL PL RO RS SI SK

113002310013

### Cars Maxi Bubbles

PRODUCT



DISPLAY



#### AREA 1

DK EE ES FI GB GR IE IT LT  
LV MT NO PT SA SE

113002010014

#### AREA 2

AT BE BG CH CZ DE FR HR  
HU LU NL PL RO RS SI SK

113002310014

**Disney Multi P.  
Maxi Bubbles**

PRODUCT  
8 007315 837002

DISPLAY  
8 007315 083706



**AREA 1**

DK EE ES FI GB GR IE IT LT  
LV MT NO PT SA SE

**113002010018**

**AREA 2**

AT BE BG CH CZ DE FR HR  
HU LU NL PL RO RS SI SK

**113002310018**

**Spider-Man  
Maxi Bubbles**

PRODUCT  
8 007315 514002

DISPLAY  
8 007315 151405



**AREA 1**

DK EE ES FI GB GR IE IT LT  
LV MT NO PT SA SE

**113002010009**

**AREA 2**

AT BE BG CH CZ DE FR HR  
HU LU NL PL RO RS SI SK

**113002310009**

**PAW Patrol  
Maxi Bubbles**

PRODUCT  
8 007315 693509

DISPLAY  
8 007315 069359



**AREA 1**

DK EE ES FI GB GR IE IT LT  
LV MT NO PT SA SE

**113002010025**

**AREA 2**

AT BE BG CH CZ DE FR HR  
HU LU NL PL RO RS SI SK

**113002310025**

**Mattel Multi P.  
Maxi Bubbles**

PRODUCT  
8 007315 839501

DISPLAY  
8 007315 083959



**AREA 1**

DK EE ES FI GB GR IE IT LT  
LV MT NO PT SA SE

**113002010038**

**AREA 2**

AT BE BG CH CZ DE FR HR  
HU LU NL PL RO RS SI SK

**113002310038**

**Peppa Pig  
Maxi Bubbles**

PRODUCT  
8 007315 598002

DISPLAY  
8 007315 159807



**AREA 1**

DK EE ES FI GB GR IE IT LT  
LV MT NO PT SA SE

**113002010023**

**AREA 2**

AT BE BG CH CZ DE FR HR  
HU LU NL PL RO RS SI SK

**113002310023**

**PJ Masks  
Maxi Bubbles**

PRODUCT



DISPLAY



**AREA 1**

DK EE ES FI GB GR IE IT LT  
LV MT NO PT SA SE

**113002010027**

**AREA 2**

AT BE BG CH CZ DE FR HR  
HU LU NL PL RO RS SI SK

**113002310027**

**Gabby's Dollhouse  
Maxi Bubbles**

PRODUCT



DISPLAY



**AREA 1**

DK EE ES FI GB GR IE IT LT  
LV MT NO PT SA SE

**113002010045**

**AREA 2**

AT BE BG CH CZ DE FR HR  
HU LU NL PL RO RS SI SK

**113002310045**

**Bing  
Maxi Bubbles**

PRODUCT



DISPLAY



**AREA 1**

DK EE ES FI GB GR IE IT LT  
LV MT NO PT SA SE

**113002010031**

**AREA 2**

AT BE BG CH CZ DE FR HR  
HU LU NL PL RO RS SI SK

**113002310031**

# Bolle di sapone Soap bubbles



**GLASS - display**  
300 ml - 10,5 fl oz UK

SOAP BUBBLES

## Safety commitment



Gluten Free.  
Hypoallergenic.  
Paraben Free.

Lotto di produzione  
impresso sulla flacone.  
*Batch of production  
printed on the bottle.*

Liquido 100%  
microbiologicamente  
testato.  
*100% microbiologically  
tested solution.*



## Environmental commitment



Riempibile e  
riutilizzabile.  
*Refillable and  
reusable.*



Componenti prodotto  
interamente riciclabili.  
*Product components  
fully recyclable.*

## Playability commitment

Soffiatore inserito  
nel tappo.  
*Built-in wand.*

Gioco sul tappo.  
*Game on the top.*

Testato per resistere alle  
diverse condizioni  
climatiche.  
*Tested to withstand  
different climatic conditions.*

Pallina di plastica  
(non si ossida).  
*Plastic ball  
(does not oxidize).*



DAT TECNICI - TECHNICAL DATA

### display

12 pz / pcs  
cm 20 x 26,5 x 17  
kg 4,3

epal pallet cm 80 x 120

8x14 display

**Classic  
Glass Bubbles**



**AREA 1**

DK EE ES FI GB GR IE IT LT  
LV MT NO PT SA SE

**113003010001**

**AREA 2**

AT BE BG CH CZ DE FR HR  
HU LU NL PL RO RS SI SK

**113003310001**

**Color  
Glass Bubbles**



**AREA 1**

DK EE ES FI GB GR IE IT LT  
LV MT NO PT SA SE

**113003010002**

**AREA 2**

AT BE BG CH CZ DE FR HR  
HU LU NL PL RO RS SI SK

**113003310002**

**Unicorn  
Glass Bubbles**



**AREA 1**

DK EE ES FI GB GR IE IT LT  
LV MT NO PT SA SE

**113003010004**

**AREA 2**

AT BE BG CH CZ DE FR HR  
HU LU NL PL RO RS SI SK

**113003310004**

**Animal  
Glass Bubbles**



**AREA 1**

DK EE ES FI GB GR IE IT LT  
LV MT NO PT SA SE

**113003010005**

**AREA 2**

AT BE BG CH CZ DE FR HR  
HU LU NL PL RO RS SI SK

**113003310005**

**NEW!**

**Stitch  
Glass Bubbles**



**AREA 1**

DK EE ES FI GB GR IE IT LT  
LV MT NO PT SA SE

**113003010043**

**AREA 2**

AT BE BG CH CZ DE FR HR  
HU LU NL PL RO RS SI SK

**113003310043**



**Mickey  
Glass Bubbles**

PRODUCT



DISPLAY



**AREA 1**

DK EE ES FI GB GR IE IT LT  
LV MT NO PT SA SE

**113003010010**

**AREA 2**

AT BE BG CH CZ DE FR HR  
HU LU NL PL RO RS SI SK

**113003310010**

**Minnie  
Glass Bubbles**

PRODUCT



DISPLAY



**AREA 1**

DK EE ES FI GB GR IE IT LT  
LV MT NO PT SA SE

**113003010011**

**AREA 2**

AT BE BG CH CZ DE FR HR  
HU LU NL PL RO RS SI SK

**113003310011**

**Princess  
Glass Bubbles**

PRODUCT



DISPLAY



**AREA 1**

DK EE ES FI GB GR IE IT LT  
LV MT NO PT SA SE

**113003010012**

**AREA 2**

AT BE BG CH CZ DE FR HR  
HU LU NL PL RO RS SI SK

**113003310012**

**Frozen  
Glass Bubbles**

PRODUCT



DISPLAY



**AREA 1**

DK EE ES FI GB GR IE IT LT  
LV MT NO PT SA SE

**113003010013**

**AREA 2**

AT BE BG CH CZ DE FR HR  
HU LU NL PL RO RS SI SK

**113003310013**

**Cars  
Glass Bubbles**

PRODUCT



DISPLAY



**AREA 1**

DK EE ES FI GB GR IE IT LT  
LV MT NO PT SA SE

**113003010014**

**AREA 2**

AT BE BG CH CZ DE FR HR  
HU LU NL PL RO RS SI SK

**113003310014**

**Disney Multi P.  
Glass Bubbles**



**AREA 1**

DK EE ES FI GB GR IE IT LT  
LV MT NO PT SA SE

**113003010018**

**AREA 2**

AT BE BG CH CZ DE FR HR  
HU LU NL PL RO RS SI SK

**113003310018**

**Spider-Man  
Glass Bubbles**



**AREA 1**

DK EE ES FI GB GR IE IT LT  
LV MT NO PT SA SE

**113003010009**

**AREA 2**

AT BE BG CH CZ DE FR HR  
HU LU NL PL RO RS SI SK

**113003310009**

**Avengers  
Glass Bubbles**



**AREA 1**

DK EE ES FI GB GR IE IT LT  
LV MT NO PT SA SE

**113003010017**

**AREA 2**

AT BE BG CH CZ DE FR HR  
HU LU NL PL RO RS SI SK

**113003310017**

**PAW Patrol  
Glass Bubbles**



**AREA 1**

DK EE ES FI GB GR IE IT LT  
LV MT NO PT SA SE

**113003010025**

**AREA 2**

AT BE BG CH CZ DE FR HR  
HU LU NL PL RO RS SI SK

**113003310025**

**Barbie  
Glass Bubbles**



**AREA 1**

DK EE ES FI GB GR IE IT LT  
LV MT NO PT SA SE

**113003010021**

**AREA 2**

AT BE BG CH CZ DE FR HR  
HU LU NL PL RO RS SI SK

**113003310021**

**Peppa Pig  
Glass Bubbles**

PRODUCT



8 007315 607001

DISPLAY



8 007315 060707



**AREA 1**

DK EE ES FI GB GR IE IT LT  
LV MT NO PT SA SE

**113003010023**

**AREA 2**

AT BE BG CH CZ DE FR HR  
HU LU NL PL RO RS SI SK

**113003310023**

**PJ Masks  
Glass Bubbles**

PRODUCT



8 007315 699006

DISPLAY



8 007315 069908



**AREA 1**

DK EE ES FI GB GR IE IT LT  
LV MT NO PT SA SE

**113003010027**

**AREA 2**

AT BE BG CH CZ DE FR HR  
HU LU NL PL RO RS SI SK

**113003310027**

**Gabby's Dollhouse  
Glass Bubbles**

PRODUCT



8 007315 008051

DISPLAY



8 007315 008068



**AREA 1**

DK EE ES FI GB GR IE IT LT  
LV MT NO PT SA SE

**113003010045**

**AREA 2**

AT BE BG CH CZ DE FR HR  
HU LU NL PL RO RS SI SK

**113003310045**

**Minions  
Glass Bubbles**

PRODUCT



8 007315 614009

DISPLAY



8 007315 061407



**AREA 1**

DK EE ES FI GB GR IE IT LT  
LV MT NO PT SA SE

**113003010028**

**AREA 2**

AT BE BG CH CZ DE FR HR  
HU LU NL PL RO RS SI SK

**113003310028**

**NEW!**

**Bluey  
Glass Bubbles**

PRODUCT



8 007315 009133

DISPLAY



8 007315 009140



**AREA 1**

DK EE ES FI GB GR IE IT LT  
LV MT NO PT SA SE

**113003010036**

**AREA 2**

AT BE BG CH CZ DE FR HR  
HU LU NL PL RO RS SI SK

**113003310036**

Bolle di sapone  
Soap bubbles



3-PACK

Environmental  
commitment



**cartone / carton**  
24 3-packs  
cm 24,5 x 32 x 24,5  
kg 6  
epal pallet cm 80 x 120  
77 ct / cts

DAT TECNICI - TECHNICAL DATA

x3

Gioco sul tappo visibile dall'esterno.  
Game on the top visible from the outside.

Grafiche assortite dei flaconi.  
Assorted bottle graphics.

**Disney Multi P.**  
Bubbles 3-pack



**AREA 1**

DK EE ES FI GB GR IE IT LT  
LV MT NO PT SA SE

103010010018

**AREA 2**

AT BE BG CH CZ DE FR HR  
HU LU NL PL RO RS SI SK

103010310018

**Frozen**  
Bubbles 3-pack



**AREA 1**

DK EE ES FI GB GR IE IT LT  
LV MT NO PT SA SE

103010010013

**AREA 2**

AT BE BG CH CZ DE FR HR  
HU LU NL PL RO RS SI SK

103010310013

**PAW Patrol**  
Bubbles 3-pack



**AREA 1**

DK EE ES FI GB GR IE IT LT  
LV MT NO PT SA SE

103010010025

**AREA 2**

AT BE BG CH CZ DE FR HR  
HU LU NL PL RO RS SI SK

103010310025

DISPONIBILE SU RICHIESTA (QUANTITÀ MINIMA NECESSARIA)  
AVAILABLE UPON REQUEST (MINIMUM ORDER QUANTITY REQUIRED)

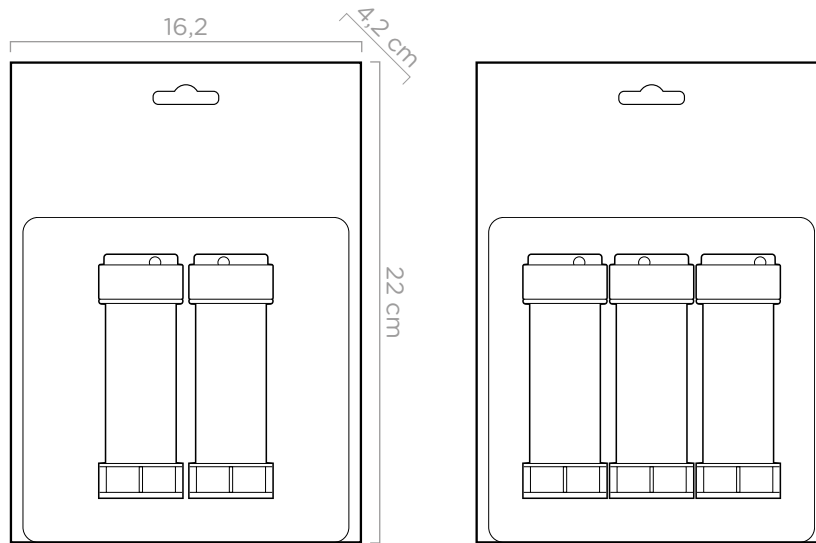

Per particolari campagne promozionali, attività speciali in-store o online.  
DISPONIBILE SU RICHIESTA (QUANTITÀ MINIMA NECESSARIA)

*For particular promotional campaigns, special in-store activities or online shops.  
AVAILABLE UPON REQUEST (MINIMUM ORDER QUANTITY REQUIRED)*



3-pack (32 pcs. per carton)



4-pack (24 pcs. per carton)



5-pack (20 pcs. per carton)



6-pack (16 pcs. per carton)



9-pack (8 pcs. per carton)



12-pack (8 pcs. per carton)

#### TECHNICAL DATA

Carton  
cm 24,5 x32 x 24,5 - kg 6,0

Pallet (high cm 187)  
77 cartons

Bolle di sapone per promuovere e comunicare il proprio brand.  
Flaconi personalizzabili per eventi, sponsorship, giveaway o sviluppo di una propria linea di prodotto. Minimi d'ordini flessibili.

*Soap bubbles to promote and communicate your brand.  
Customizable bottles for events, sponsorships, giveaways or development of your own product line. Flexible minimum order quantity.*

DIVERSI FORMATI DISPONIBILI  
DIFFERENT SIZES AVAILABLE



YOUR  
LOGO  
HERE

- EVENTI / EVENTS
- SPONSORSHIP
- GIVEAWAY
- PUBBLICITÀ / ADS
- FESTIVITÀ / HOLIDAYS
- SOUVENIR

FESTIVITÀ  
HOLIDAYS



EVENTI E  
CELEBRAZIONI  
EVENTS AND  
CELEBRATIONS



SOUVENIR



CONTINUA / CONTINUE →

GLI EVENTI - CASE HISTORY



BOLOGNA PORTICI FESTIVAL



credits: Comune di Bologna - Giorgio Bianchi

GIFFONI FILM FESTIVAL



PARMA CALCIO



TOUR DE FRANCE





# Bolle Party

## *Party Bubbles*



## Bolle di sapone Soap bubbles



**STANDARD - display**  
60 ml - 2,1 fl oz UK

Ideale per le feste tutto l'anno.  
Perfect for parties all year round.



Grafiche dei flaconi assortite.  
Assorted bottle graphics.

Scrivi il tuo nome.  
Write your name.

DAT TECNICI - TECHNICAL DATA

**display**  
36 pz / pcs  
cm 23,5 x 23,5 x 12

**cartone / carton**  
6 displays  
216 pz / pcs  
cm 25 x 48,7 x 37  
kg 17,4

epal pallet cm 80 x 120  
30 ct / cts

BOLLE PARTY

**x36**

### Party Bubbles

PRODUCT



8 007315 438001

DISPLAY



8 007315 043809



#### AREA 1

DK EE ES FI GB  
GR IE IT LT LV MT  
NO PT SA SE

**103001010006**

#### AREA 2

AT BE BG CH CZ  
DE FR HR HU LU NL  
PL RO RS SI SK

**103001310006**

## Bolle di sapone Soap bubbles



**PARTY PACK**

Confezione portatile con comodo manico.  
Portable package with comfortable handle.

Ideale per le feste tutto l'anno.  
Perfect for parties all year round.



Grafiche dei flaconi assortite.  
Assorted bottle graphics.

Scrivi il tuo nome.  
Write your name.

DAT TECNICI - TECHNICAL DATA

**scatola / box**  
6 pz / pcs  
cm 11,5 x 7,5 x 11,5

**cartone / carton**  
12 party pack  
cm 25 x 24 x 25  
kg 6

epal pallet cm 80 x 120  
105 ct / cts

**x6**

### Party Bubbles Party Pack 6pcs.

6-PACK



8 007315 830003



#### AREA 1

DK EE ES FI GB  
GR IE IT LT LV MT  
NO PT SA SE

**103012010006**

#### AREA 2

AT BE BG CH CZ  
DE FR HR HU LU NL  
PL RO RS SI SK

**103012310006**



Portatile.  
Portable.



Alimentatore di rete incluso.  
Power supply included.

Manico retrattile.  
Retractable handle.



h 14 cm

18 cm

22 cm

Serbatoio contenente 300ml (10,55 fl.oz. UK)  
di liquido per bolle di sapone\*.  
300ml (10,55 fl.oz. UK) bubble\* tank capacity.

\*Liquido per bolle di sapone non incluso.  
\*Soap bubble solution not included.



Necessita 2 batterie C.  
2CBatteries needed.

DAT TECNICI - TECHNICAL DATA

scatola / box

cm 19,5 x 28 x 17  
Kg 0,8

epal pallet cm 80 x 120

96 ct / cts

## Bubble Machine

BUBBLE MACHINE



8 007315 205009



AREA 1

AREA 2

500034010000



@BubbleWorldToys



# Ricarica bolle

## *Bubble refill*



BUBBLE REFILL

**bubble  
world**



**BUBBLE  
REFILL**

READY TO USE  
RESISTANT AND BRIGHT

RICARICA LIQUIDO PER BOLLE DI SAPONE  
PRONTO ALL'USO, RESISTENTE E LUCENTE



@BubbleWorldToys



www.bubbleworld.com

# Ricarica bolle Bubble Refill



# BUBBLE REFILL 0.5 BUBBLE REFILL 1.0

### Safety commitment



Gluten Free.  
Hypoallergenic.  
Paraben Free.

Lotto di produzione  
impresso sul flacone.  
*Batch of production  
printed on the bottle.*

Liquido 100%  
microbiologicamente  
testato.

*100% microbiologically  
tested solution.*

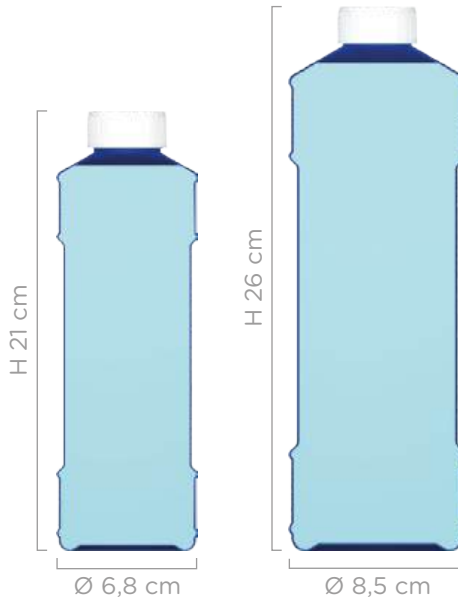

### Environmental commitment

Flacone e tappo in  
mono materiale.  
*Mono-material bottle  
and cap.*

Componenti prodotto  
interamente riciclabili.  
*Product components  
fully recyclable.*

RICARICA BOLLE

### REFILL 0.5

**flacone / bottle**  
0,5 L - 17,5 fl oz UK  
**cartone / carton**  
25 pz/pcs  
cm 35,3 x 35,3 x 23,2  
kg 14  
**epal pallet cm 80 x 120**  
42 ct / cts

DAT TECNICI - TECHNICAL DATA

### Playability commitment

Testato per resistere alle diverse condizioni climatiche.  
*Tested to withstand different climatic conditions.*

Pronto all'uso.  
*Ready to use.*

**LIQUIDO MULTIUSO PER BOLLE E GIOCABOLLE.  
MULTIPURPOSE SOLUTION FOR BUBBLES AND BUBBLE TOYS.**

### REFILL 1.0

**flacone / bottle**  
1 L - 35,1 fl oz UK  
**cartone / carton**  
12 pz/pcs  
cm 26 x 34,5 x 28  
kg 13,1  
**epal pallet cm 80 x 120**  
45 ct / cts

DAT TECNICI - TECHNICAL DATA

## Bubble Refill 0.5



### AREA 1

DK EE ES FI GB GR IE IT LT  
LV MT NO PT SA SE

**103004010000**

### AREA 2

AT BE BG CH CZ DE FR HR  
HU LU NL PL RO RS SI SK

**103004310000**

## Bubble Refill 1.0



### AREA 1

DK EE ES FI GB GR IE IT LT  
LV MT NO PT SA SE

**103005010000**

### AREA 2

AT BE BG CH CZ DE FR HR  
HU LU NL PL RO RS SI SK

**103005310000**

**Safety  
commitment**



Gluten Free.  
Hypoallergenic.  
Paraben Free.

Lotto di produzione  
impresso sul flacone.  
*Batch of production  
printed on the bottle.*

Liquido 100%  
microbiologicamente  
testato.  
*100% microbiologically  
tested solution.*

**Environmental  
commitment**

Flacone e tappo in  
mono materiale.  
*Mono-material bottle  
and cap.*

Componenti prodotto  
interamente riciclabili.  
*Product components  
fully recyclable.*



**REFILL 3.0**

flacone / bottle

3 L - 0,66 gal UK

cartone / carton

4 pz/pcs

cm 40 x 30 x 19

kg 13,3

epal pallet cm 80 x 120

40 ct / cts

DAT TECNICI - TECHNICAL DATA

**Playability commitment**

Testato per resistere alle diverse condizioni climatiche.  
*Tested to withstand different climatic conditions.*

Pronto all'uso.  
*Ready to use.*

**LIQUIDO MULTIUSO PER BOLLE E GIOCABOLLE.  
MULTIPURPOSE SOLUTION FOR BUBBLES AND BUBBLE TOYS.**

**REFILL 5.0**

flacone / bottle

5 L - 1,09 gal UK  
kg 5,40

epal pallet cm 80 x 120

90 pz / pcs

DAT TECNICI - TECHNICAL DATA

BUBBLE REFILL

**Bubble  
Refill 3.0**



**AREA 1**

DK EE ES FI GB GR IE IT LT  
LV MT NO PT SA SE

**103006010000**

**AREA 2**

AT BE BG CH CZ DE FR HR  
HU LU NL PL RO RS SI SK

**103006310000**

**Bubble  
Refill 5.0**



**AREA 1**

DK EE ES FI GB GR IE IT LT  
LV MT NO PT SA SE

**123007010000**

**AREA 2**

AT BE BG CH CZ DE FR HR  
HU LU NL PL RO RS SI SK

**123007310000**



@BubbleWorldToys





# Giocabolle™ *Bubble Toys*



BUBBLE TOYS

**Safety commitment**



Gluten Free.  
Hypoallergenic.  
Paraben Free.

Lotto di produzione  
impresso sulla spada.

*Batch of production  
printed on the wand.*

Liquido 100%  
microbiologicamente  
testato.

*100% microbiologically  
tested solution.*

**Playability commitment**

Soffiatore inserito nel  
manico per fare bolle maxi.

*Built-in wand to make  
maxi bubbles.*

Foro grande adatto ai  
ganci espositori.

*Large hollow for easy  
hanging in universal  
blister hooks.*

Testato per resistere alle  
diverse condizioni  
climatiche.

*Tested to withstand  
different climatic conditions.*



**Environmental commitment**



Riempibile e  
riutilizzabile.  
*Refillable and  
reusable.*



Componenti prodotto  
interamente riciclabili.  
*Product components  
fully recyclable.*

DAT TECNICI - TECHNICAL DATA

**spada / wand**

120 ml - 4,2 fl oz UK

**display**

24 pz / pcs  
cm 16 x 23 x 39  
kg 4,1

epal pallet cm 80 x 120

125 ct / cts

GIOCABOLLE

**Classic**  
**Bubble Wand 120ml**



**AREA 1**

DK EE ES FI GB GR IE IT LT  
LV MT NO PT SA SE

**500025010001**

**AREA 2**

AT BE BG CH CZ DE FR HR  
HU LU NL PL RO RS SI SK

**500025310001**

**Unicorn**  
**Bubble Wand 120ml**



**AREA 1**

DK EE ES FI GB GR IE IT LT  
LV MT NO PT SA SE

**500025010004**

**AREA 2**

AT BE BG CH CZ DE FR HR  
HU LU NL PL RO RS SI SK

**500025310004**

**Animal**  
Bubble Wand 120ml



**AREA 1**

DK EE ES FI GB GR IE IT LT  
LV MT NO PT SA SE

**500025010005**

**AREA 2**

AT BE BG CH CZ DE FR HR  
HU LU NL PL RO RS SI SK

**500025310005**

**Stitch**  
Bubble Wand 120ml



**AREA 1**

DK EE ES FI GB GR IE IT LT  
LV MT NO PT SA SE

**500025010043**

**AREA 2**

AT BE BG CH CZ DE FR HR  
HU LU NL PL RO RS SI SK

**500025310043**

**Mickey**  
Bubble Wand 120ml



**AREA 1**

DK EE ES FI GB GR IE IT LT  
LV MT NO PT SA SE

**500025010010**

**AREA 2**

AT BE BG CH CZ DE FR HR  
HU LU NL PL RO RS SI SK

**500025310010**

**Minnie**  
Bubble Wand 120ml



**AREA 1**

DK EE ES FI GB GR IE IT LT  
LV MT NO PT SA SE

**500025010011**

**AREA 2**

AT BE BG CH CZ DE FR HR  
HU LU NL PL RO RS SI SK

**500025310011**

**Princess**  
Bubble Wand 120ml



**AREA 1**

DK EE ES FI GB GR IE IT LT  
LV MT NO PT SA SE

**500025010012**

**AREA 2**

AT BE BG CH CZ DE FR HR  
HU LU NL PL RO RS SI SK

**500025310012**

**Frozen**  
Bubble Wand 120ml



**AREA 1**

DK EE ES FI GB GR IE IT LT  
LV MT NO PT SA SE

**500025010013**

**AREA 2**

AT BE BG CH CZ DE FR HR  
HU LU NL PL RO RS SI SK

**500025310013**

**Disney Multi P.**  
Bubble Wand 120ml



**AREA 1**

DK EE ES FI GB GR IE IT LT  
LV MT NO PT SA SE

**500025010018**

**AREA 2**

AT BE BG CH CZ DE FR HR  
HU LU NL PL RO RS SI SK

**500025310018**

**Spider-Man**  
Bubble Wand 120ml



**AREA 1**

DK EE ES FI GB GR IE IT LT  
LV MT NO PT SA SE

**500025010009**

**AREA 2**

AT BE BG CH CZ DE FR HR  
HU LU NL PL RO RS SI SK

**500025310009**

**Avengers**  
Bubble Wand 120ml



**AREA 1**

DK EE ES FI GB GR IE IT LT  
LV MT NO PT SA SE

**500025010017**

**AREA 2**

AT BE BG CH CZ DE FR HR  
HU LU NL PL RO RS SI SK

**500025310017**

**PAW Patrol**  
Bubble Wand 120ml



**AREA 1**

DK EE ES FI GB GR IE IT LT  
LV MT NO PT SA SE

**500025010025**

**AREA 2**

AT BE BG CH CZ DE FR HR  
HU LU NL PL RO RS SI SK

**500025310025**

**Peppa Pig**  
Bubble Wand 120ml



**AREA 1**

DK EE ES FI GB GR IE IT LT  
LV MT NO PT SA SE

**500025010023**

**AREA 2**

AT BE BG CH CZ DE FR HR  
HU LU NL PL RO RS SI SK

**500025310023**

**Gabby's Dollhouse**  
Bubble Wand 120ml



**AREA 1**

DK EE ES FI GB GR IE IT LT  
LV MT NO PT SA SE

**500025010045**

**AREA 2**

AT BE BG CH CZ DE FR HR  
HU LU NL PL RO RS SI SK

**500025310045**

**Minions**  
Bubble Wand 120ml



**AREA 1**

DK EE ES FI GB GR IE IT LT  
LV MT NO PT SA SE

**500025010028**

**AREA 2**

AT BE BG CH CZ DE FR HR  
HU LU NL PL RO RS SI SK

**500025310028**

**Bing**  
Bubble Wand 120ml



**AREA 1**

DK EE ES FI GB GR IE IT LT  
LV MT NO PT SA SE

**500025010031**

**AREA 2**

AT BE BG CH CZ DE FR HR  
HU LU NL PL RO RS SI SK

**500025310031**

**Sonic**  
Bubble Wand 120ml



**AREA 1**

DK EE ES FI GB GR IE IT LT  
LV MT NO PT SA SE

**500025010044**

**AREA 2**

AT BE BG CH CZ DE FR HR  
HU LU NL PL RO RS SI SK

**500025310044**





x1



Environmental  
commitment



FUNZIONA SENZA BATTERIE  
NO BATTERIES NEEDED

**Premere:**

- a) continuamente per una lunga fila di bolle
- b) ad intervalli per bolle grandi.

**Pull the trigger:**

- a) continuously to get a lot of bubbles
- b) intermittently to get big bubbles.



Pistola Meccanica  
Mechanical Gun

DATI TECNICI - TECHNICAL DATA

**blistercard**

cm 16 x 22

**cartone / carton**

27 blistercards  
cm 20,5 x 80,5 x 28,5  
kg 4,4

**epal pallet cm 80 x 120**

42 ct / cts

**Classic**

Bubble Gun - Small

GUN SMALL



8 007315 960007



**AREA 1**

DK EE ES FI GB GR IE IT LT  
LV MT NO PT SA SE

500026010001

**AREA 2**

AT BE BG CH CZ DE FR HR  
HU LU NL PL RO RS SI SK

500026310001

**Unicorn**

Bubble Gun - Small

GUN SMALL



8 007315 175012



**AREA 1**

DK EE ES FI GB GR IE IT LT  
LV MT NO PT SA SE

500026010004

**AREA 2**

AT BE BG CH CZ DE FR HR  
HU LU NL PL RO RS SI SK

500026310004

**Animal**

Bubble Gun - Small

GUN SMALL



8 007315 176019



**AREA 1**

DK EE ES FI GB GR IE IT LT  
LV MT NO PT SA SE

500026010005

**AREA 2**

AT BE BG CH CZ DE FR HR  
HU LU NL PL RO RS SI SK

500026310005

**Mickey**  
Bubble Gun - Small



**AREA 1**

DK EE ES FI GB GR IE IT LT  
LV MT NO PT SA SE

**500026010010**

**AREA 2**

AT BE BG CH CZ DE FR HR  
HU LU NL PL RO RS SI SK

**500026310010**

**Minnie**  
Bubble Gun - Small



**AREA 1**

DK EE ES FI GB GR IE IT LT  
LV MT NO PT SA SE

**500026010011**

**AREA 2**

AT BE BG CH CZ DE FR HR  
HU LU NL PL RO RS SI SK

**500026310011**

**Frozen**  
Bubble Gun - Small



**AREA 1**

DK EE ES FI GB GR IE IT LT  
LV MT NO PT SA SE

**500026010013**

**AREA 2**

AT BE BG CH CZ DE FR HR  
HU LU NL PL RO RS SI SK

**500026310013**

**Cars**  
Bubble Gun - Small



**AREA 1**

DK EE ES FI GB GR IE IT LT  
LV MT NO PT SA SE

**500026010014**

**AREA 2**

AT BE BG CH CZ DE FR HR  
HU LU NL PL RO RS SI SK

**500026310014**

**Spider-Man**  
Bubble Gun - Small



**AREA 1**

DK EE ES FI GB GR IE IT LT  
LV MT NO PT SA SE

**500026010009**

**AREA 2**

AT BE BG CH CZ DE FR HR  
HU LU NL PL RO RS SI SK

**500026310009**



**PAW Patrol**  
Bubble Gun - Small



**AREA 1**

DK EE ES FI GB GR IE IT LT  
LV MT NO PT SA SE

**500026010025**

**AREA 2**

AT BE BG CH CZ DE FR HR  
HU LU NL PL RO RS SI SK

**500026310025**

**Peppa Pig**  
Bubble Gun - Small



**AREA 1**

DK EE ES FI GB GR IE IT LT  
LV MT NO PT SA SE

**500026010023**

**AREA 2**

AT BE BG CH CZ DE FR HR  
HU LU NL PL RO RS SI SK

**500026310023**

**PJ Masks**  
Bubble Gun - Small



**AREA 1**

DK EE ES FI GB GR IE IT LT  
LV MT NO PT SA SE

**500026010027**

**AREA 2**

AT BE BG CH CZ DE FR HR  
HU LU NL PL RO RS SI SK

**500026310027**

**Gabby's Dollhouse**  
Bubble Gun - Small



**AREA 1**

DK EE ES FI GB GR IE IT LT  
LV MT NO PT SA SE

**500026010045**

**AREA 2**

AT BE BG CH CZ DE FR HR  
HU LU NL PL RO RS SI SK

**500026310045**

**Bing**  
Bubble Gun - Small



**AREA 1**

DK EE ES FI GB GR IE IT LT  
LV MT NO PT SA SE

**500026010031**

**AREA 2**

AT BE BG CH CZ DE FR HR  
HU LU NL PL RO RS SI SK

**500026310031**





x1



**Environmental commitment**

DAT TECNICI - TECHNICAL DATA	<b>cartone / carton</b>
	48 guns cm 20,5 x 80,5 x 28,5 kg 6,4
	epal pallet cm 80 x 120
	42 ct / cts

**Premere:**

- a) continuamente per una lunga fila di bolle
- b) ad intervalli per bolle grandi.

**Pull the trigger:**

- a) continuously to get a lot of bubbles
- b) intermittently to get big bubbles.



Pistola Meccanica  
Mechanical Gun

**Classic**

Bubble Gun - Small  
(shrink-film)

GUN SMALL (SHRINK-FILM)



8 007315 280006



**AREA 1**

DK EE ES FI GB GR IE IT LT  
LV MT NO PT SA SE

500027010001

**AREA 2**

AT BE BG CH CZ DE FR HR  
HU LU NL PL RO RS SI SK

500027310001

**Mickey**

Bubble Gun - Small  
(shrink-film)

GUN SMALL (SHRINK-FILM)



8 007315 080507



**AREA 1**

DK EE ES FI GB GR IE IT LT  
LV MT NO PT SA SE

500027010010

**AREA 2**

AT BE BG CH CZ DE FR HR  
HU LU NL PL RO RS SI SK

500027310010

**Minnie**

Bubble Gun - Small  
(shrink-film)

GUN SMALL (SHRINK-FILM)



8 007315 084505



**AREA 1**

DK EE ES FI GB GR IE IT LT  
LV MT NO PT SA SE

500027010011

**AREA 2**

AT BE BG CH CZ DE FR HR  
HU LU NL PL RO RS SI SK

500027310011

### Frozen

Bubble Gun - Small  
(shrink-film)

GUN SMALL (SHRINK-FILM)



8 007315 250115



**AREA 1**

DK EE ES FI GB GR IE IT LT  
LV MT NO PT SA SE

500027010013

**AREA 2**

AT BE BG CH CZ DE FR HR  
HU LU NL PL RO RS SI SK

500027310013

### Spider-Man

Bubble Gun - Small  
(shrink-film)

GUN SMALL (SHRINK-FILM)



8 007315 081504



**AREA 1**

DK EE ES FI GB GR IE IT LT  
LV MT NO PT SA SE

500027010009

**AREA 2**

AT BE BG CH CZ DE FR HR  
HU LU NL PL RO RS SI SK

500027310009

### PAW Patrol

Bubble Gun - Small  
(shrink-film)

GUN SMALL (SHRINK-FILM)



8 007315 173100



**AREA 1**

DK EE ES FI GB GR IE IT LT  
LV MT NO PT SA SE

500027010025

**AREA 2**

AT BE BG CH CZ DE FR HR  
HU LU NL PL RO RS SI SK

500027310025





Environmental  
commitment



NESSUNA BATTERIA DA AGGIUNGERE  
NO BATTERIES TO ADD

x1



Con luce (batterie incorporate).  
With light (built-in batteries).

Premere:

- a) continuamente per una lunga fila di bolle
- b) ad intervalli per bolle grandi.

Pull the trigger:

- a) continuously to get a lot of bubbles
- b) intermittently to get big bubbles.



Pistola Meccanica  
Mechanical Gun

DATI TECNICI - TECHNICAL DATA

blistercard

cm 18,5 x 24

cartone / carton

20 blistercards  
cm 20,5 x 80,5 x 28,5  
kg 3,9

epal pallet cm 80 x 120

42 ct / cts

### Classic

Bubble Gun - Medium

GUN MEDIUM



8 007315 085007



#### AREA 1

DK EE ES FI GB GR IE IT LT  
LV MT NO PT SA SE

500028010001

#### AREA 2

AT BE BG CH CZ DE FR HR  
HU LU NL PL RO RS SI SK

500028310001

### Unicorn

Bubble Gun - Medium

GUN MEDIUM



8 007315 210515



#### AREA 1

DK EE ES FI GB GR IE IT LT  
LV MT NO PT SA SE

500028010004

#### AREA 2

AT BE BG CH CZ DE FR HR  
HU LU NL PL RO RS SI SK

500028310004

### NEW!

### Stitch

Bubble Gun - Medium

GUN MEDIUM



8 007315 008518



#### AREA 1

DK EE ES FI GB GR IE IT LT  
LV MT NO PT SA SE

500028010043

#### AREA 2

AT BE BG CH CZ DE FR HR  
HU LU NL PL RO RS SI SK

500028310043

## Mickey

Bubble Gun - Medium

GUN MEDIUM



8 007315 085502



### AREA 1

DK EE ES FI GB GR IE IT LT  
LV MT NO PT SA SE

500028010010

### AREA 2

AT BE BG CH CZ DE FR HR  
HU LU NL PL RO RS SI SK

500028310010

## Frozen

Bubble Gun - Medium

GUN MEDIUM



8 007315 211512



### AREA 1

DK EE ES FI GB GR IE IT LT  
LV MT NO PT SA SE

500028010013

### AREA 2

AT BE BG CH CZ DE FR HR  
HU LU NL PL RO RS SI SK

500028310013

## Spider-Man

Bubble Gun - Medium

GUN MEDIUM



8 007315 086004



### AREA 1

DK EE ES FI GB GR IE IT LT  
LV MT NO PT SA SE

500028010009

### AREA 2

AT BE BG CH CZ DE FR HR  
HU LU NL PL RO RS SI SK

500028310009

## PAW Patrol

Bubble Gun - Medium

GUN MEDIUM



8 007315 089500



### AREA 1

DK EE ES FI GB GR IE IT LT  
LV MT NO PT SA SE

500028010025

### AREA 2

AT BE BG CH CZ DE FR HR  
HU LU NL PL RO RS SI SK

500028310025

## Gabby's Dollhouse

Bubble Gun - Medium

GUN MEDIUM



8 007315 008112



### AREA 1

DK EE ES FI GB GR IE IT LT  
LV MT NO PT SA SE

500028010045

### AREA 2

AT BE BG CH CZ DE FR HR  
HU LU NL PL RO RS SI SK

500028310045



BUBBLE TOYS



Environmental  
commitment



FUNZIONA SENZA BATTERIE  
NO BATTERIES NEEDED

Bolle senza fine: le bolle escono senza sosta fino a che si preme ripetutamente il grilletto.  
*Endless bubbles: pull the trigger repeatedly for a continuous flow of bubbles.*

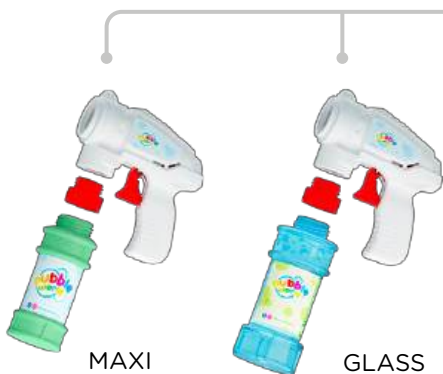

MAXI

GLASS

x1

Connettore universale per tutti i flaconi BUBBLE WORLD™ (Standard, Maxi, Glass, ecc.)  
*Universal connector for all our BUBBLE WORLD™ bottles (Standard, Maxi, Glass, etc.)*

Pistola Meccanica  
*Mechanical Gun*

DAT TECNICI - TECHNICAL DATA	<b>blistercard</b>
	cm 21 x 26
	<b>cartone / carton</b>
	12 blistercards cm 20,5 x 80,5 x 28,5 kg 3,32
	<b>epal pallet cm 80 x 120</b>
	42 ct / cts

**Classic**  
Bubble Gun Plus

GUN PLUS

8 007315 094016

**AREA 1**

DK EE ES FI GB GR IE IT LT  
LV MT NO PT SA SE

**500029010001**

---

**AREA 2**

AT BE BG CH CZ DE FR HR  
HU LU NL PL RO RS SI SK

**500029310001**

Environmental  
commitment



Bacchette modulari  
per bolle giganti  
*Modular sticks  
for giant bubbles*

Vaschetta  
contenitore  
*Bowl*

2x175= 350 ml  
di liquido bolle  
*2x175= 350 ml  
of bubble solution*

DATI TECNICI - TECHNICAL DATA

<b>box</b>	cm 6,5 x 15 x 27
<b>cartone / carton</b>	12 box cm 20,5 x 80,5 x 28,5 kg 7,2
<b>epal pallet</b>	cm 80 x 120
	42 ct / cts



**Classic**  
Giant Bubble Kit

GIANT BUBBLE KIT



8 007315 013505



**AREA 1**

DK EE ES FI GB GR IE IT LT  
LV MT NO PT SA SE

**500032010001**

**AREA 2**

AT BE BG CH CZ DE FR HR  
HU LU NL PL RO RS SI SK

**500032310001**

Environmental  
commitment



Ø 22 cm

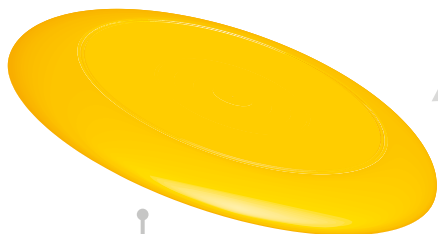
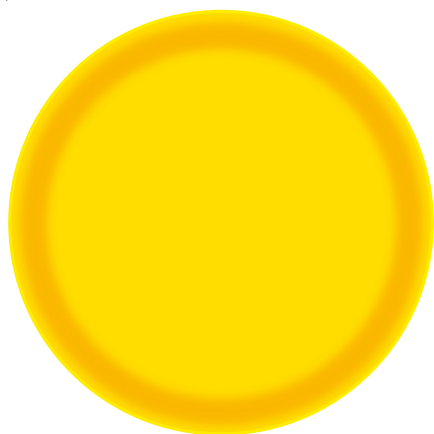

Soffiatore multiplo per fare bolle giganti e piccole.  
Multiple bubble blower to make giant and small bubbles.

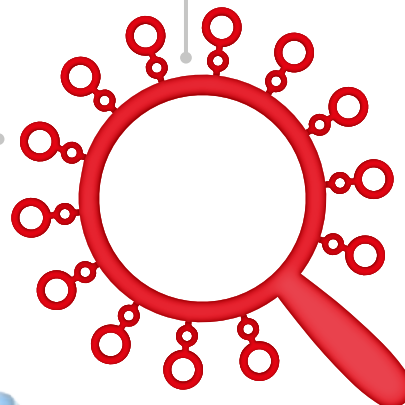

Attacca l'adesivo in dotazione sopra il flying Disc.  
Attach the supplied sticker on the flying disc.

Capovolgi il piatto e gioca col flying disc.  
Flip the plate and play with the flying disc.

DAT TECNICI - TECHNICAL DATA	<b>blistercard</b>
	cm 24,5 x 34,5
	<b>cartone / carton</b>
	12 blistercards cm 20,5 x 80,5 x 28,5 kg 5,1
	<b>epal pallet cm 80 x 120</b>
	42 ct / cts

x3

GIOCABOLLE

**Classic**  
Flying Disc &  
Giant Bubbles

FLYING DISC & GIANT BUBBLES



8 007315 500111



**AREA 1**

DK EE ES FI GB GR IE IT LT  
LV MT NO PT SA SE

500030010001

**AREA 2**

AT BE BG CH CZ DE FR HR  
HU LU NL PL RO RS SI SK

500030310001

**Mickey**  
Flying Disc &  
Giant Bubbles

FLYING DISC & GIANT BUBBLES



8 007315 110501



**AREA 1**

DK EE ES FI GB GR IE IT LT  
LV MT NO PT SA SE

500030010010

**AREA 2**

AT BE BG CH CZ DE FR HR  
HU LU NL PL RO RS SI SK

500030310010



**Minnie**  
Flying Disc &  
Giant Bubbles

FLYING DISC & GIANT BUBBLES



8 007315 111003



**AREA 1**

DK EE ES FI GB GR IE IT LT  
LV MT NO PT SA SE

**500030010011**

**AREA 2**

AT BE BG CH CZ DE FR HR  
HU LU NL PL RO RS SI SK

**500030310011**

**Frozen**  
Flying Disc &  
Giant Bubbles

FLYING DISC & GIANT BUBBLES



8 007315 115506



**AREA 1**

DK EE ES FI GB GR IE IT LT  
LV MT NO PT SA SE

**500030010013**

**AREA 2**

AT BE BG CH CZ DE FR HR  
HU LU NL PL RO RS SI SK

**500030310013**

**Cars**  
Flying Disc &  
Giant Bubbles

FLYING DISC & GIANT BUBBLES



8 007315 111508



**AREA 1**

DK EE ES FI GB GR IE IT LT  
LV MT NO PT SA SE

**500030010014**

**AREA 2**

AT BE BG CH CZ DE FR HR  
HU LU NL PL RO RS SI SK

**500030310014**

**Spider-Man**  
Flying Disc &  
Giant Bubbles

FLYING DISC & GIANT BUBBLES



8 007315 112000



**AREA 1**

DK EE ES FI GB GR IE IT LT  
LV MT NO PT SA SE

**500030010009**

**AREA 2**

AT BE BG CH CZ DE FR HR  
HU LU NL PL RO RS SI SK

**500030310009**

**PAW Patrol**  
Flying Disc &  
Giant Bubbles

FLYING DISC & GIANT BUBBLES



8 007315 117500



**AREA 1**

DK EE ES FI GB GR IE IT LT  
LV MT NO PT SA SE

**500030010025**

**AREA 2**

AT BE BG CH CZ DE FR HR  
HU LU NL PL RO RS SI SK

**500030310025**

**PJ Masks**  
Flying Disc &  
Giant Bubbles

FLYING DISC & GIANT BUBBLES



8 007315 117005



**AREA 1**

DK EE ES FI GB GR IE IT LT  
LV MT NO PT SA SE

**500030010027**

**AREA 2**

AT BE BG CH CZ DE FR HR  
HU LU NL PL RO RS SI SK

**500030310027**

**Minions**  
Flying Disc &  
Giant Bubbles

FLYING DISC & GIANT BUBBLES



8 007315 114509



**AREA 1**

DK EE ES FI GB GR IE IT LT  
LV MT NO PT SA SE

**500030010028**

**AREA 2**

AT BE BG CH CZ DE FR HR  
HU LU NL PL RO RS SI SK

**500030310028**



# Bolle di plastica e palline

## *Plastic Bubbles & Marbles*





Pasta gradevole all'olfatto.  
*Pleasant olfactive smell paste.*

Ideali 365 giorni all'anno e  
per luoghi al chiuso.  
*Ideal all year around  
and for indoor.*

H 10,5 cm



Contenuto: 30gr.  
*Content: 30gr.*

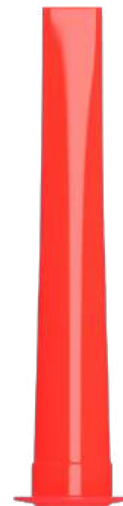

Cannuccia con valvola di  
sicurezza che impedisce  
l'inspirazione.  
*Straw with safety  
valve that prevents the  
inhalation.*



DAT TECNICI - TECHNICAL DATA	<b>display</b>
	24 pz / pcs cm 17 x 25,2 x 11
	<b>cartone / carton</b>
	12 displays 288 pz/pcs cm 27,5 x 52 x 48 kg 17,4
	epal pallet cm 80 x 120 18 ct / cts

DAT TECNICI - TECHNICAL DATA	<b>blistercard</b>
	cm 16,2 x 22
	<b>cartone / carton</b>
	24 blistercards cm 25 x 32 x 25 kg 1,7
	epal pallet cm 80 x 120 77 ct / cts

Ø 2,8 cm

**Balloo Ball**



**AREA 1**

DK EE ES FI GB GR IE IT LT  
LV MT NO PT SA SE

**103023010000**

**AREA 2**

AT BE BG CH CZ DE FR HR  
HU LU NL PL RO RS SI SK

**103023310000**

**Balloo Ball Blister**



**AREA 1**

DK EE ES FI GB GR IE IT LT  
LV MT NO PT SA SE

**103024010000**

**AREA 2**

AT BE BG CH CZ DE FR HR  
HU LU NL PL RO RS SI SK

**103024310000**

Espositore pall-box Balloo Ball  
*Balloo Ball floor display*



DAT TECNICI - TECHNICAL DATA	<b>pall box</b>
	1 pall-box cm 40 x 60 x 87 kg 8,78
	epal pallet cm 80 x 120
	8 ct / cts

133023110001  
Pall box Balloo Ball 96 pcs.

DAT TECNICI - TECHNICAL DATA	<b>pall box</b>
	1 pall-box cm 40 x 60 x 87 kg 11,28
	epal pallet cm 80 x 120
	8 ct / cts

133023010000  
Pall box Balloo Ball 144 pcs.



Ø 3,7 cm



fonte: bigliedspiaggia.it



fonte: bigliedspiaggia.it

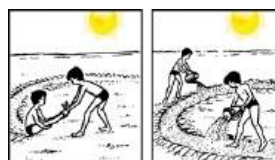

DRAW

WET



PLAY

DAT TECNICI - TECHNICAL DATA

retina / net

9 pz / pcs

interno / inner

24 retine / nets

cartone / carton

216 retine / nets

cm 42 x 59 x 53

kg 15

epal pallet cm 80 x 120

12 ct / cts

### Ciclisti

Palline di plastica

PRODUCT



8 007315 320009



AREA 1

AREA 2

103033010039

### Sport Car

Palline di plastica

PRODUCT



8 007315 327008



AREA 1

AREA 2

103033010040

### Motor Bike

Palline di plastica

PRODUCT



8 007315 329002



AREA 1

AREA 2

103033010041

### Disney Multi P.

Palline di plastica

PRODUCT



8 007315 333009



AREA 1

AREA 2

103033010018

BOLLE DI PLASTICA E PALLINE

**Bolle di plastica e palline**  
*Plastic Bubbles & Marbles*



**BIGLIE DI VETRO**  
**GLASS MARBLES**



Ø 25 mm

**1**

**+**

Dimensioni 1:1  
1:1: Dimensions



Ø 16 mm

**20**



DAT TECNICI - TECHNICAL DATA	retina / net
	21 pz / pcs
	cartone / carton
	20 retine / nets cm 26,5 x 17,8 x 9,8 kg 3
epal pallet cm 80 x 120	
288 ct / cts	

**Princess**  
**Glass Marbles Assorted**

PRODUCT



DISPLAY



AREA 1 AREA 2

500420000



**Cars**  
**Glass Marbles Assorted**

PRODUCT



DISPLAY



AREA 1 AREA 2

500410000



**Trolls**  
**Glass Marbles Assorted**

PRODUCT



DISPLAY



AREA 1 AREA 2

500450000



PLASTIC BUBBLES & MARBLES

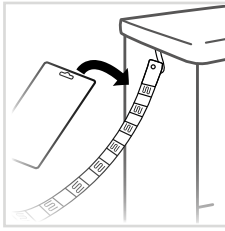

Clip strip laterali complete di ganci per una maggiore superficie espositiva.

*Side clip strips and hooks for a larger display area.*



Retro pall-box decorato: può essere collocato in posizioni espositive centrali del punto vendita.

*Backside decorated pall-box: it can be exhibited in a central position of the shop.*



DAT TECNICI - TECHNICAL DATA	cartone / carton
	1 pall-box
	cm 29 x 52,5 x 163
	kg 2
	epal pallet cm 80 x 120
	6 ct / cts

Esempio multiprodotto con clip strip laterali.  
*Example multiproduct with side clip strips.*



Esempio monoprodotto.  
*Example monoproduct.*



Esempi di possibili assortimenti  
*Examples of potential assorted displays*



# Bubble World: una bolla, un sorriso

## *Bubble World: one bubble, one smile*

Crediamo che una bolla di sapone sia uno strumento potente, in grado di regalare un sorriso a chi ne ha più bisogno. Una magia adatta a tutti e per tutte le età.

Ogni anno sosteniamo associazioni e scuole attraverso la donazione delle nostre bolle di sapone e collaboriamo con numerose realtà impegnate nel sociale e nel sostegno pediatrico attraverso attività e raccolte fondi finalizzate all'acquisto di materiali e attrezzature medico-scientifiche.

*We believe that soap bubbles are powerful tools, capable of bringing a smile to those who need it the most. They are magic, suitable for everyone and for all ages. Every year, we support associations and schools through donations of our soap bubbles and we collaborate with numerous charities engaged in social and pediatric support aimed at purchasing materials and medical-scientific equipment.*



BOLLE DI SAPONE

BOLLE PARTY

RICARICA BOLLE

GIOCABOLLE

BOLLE DI PLASTICA E PALLINE

PALL-BOX

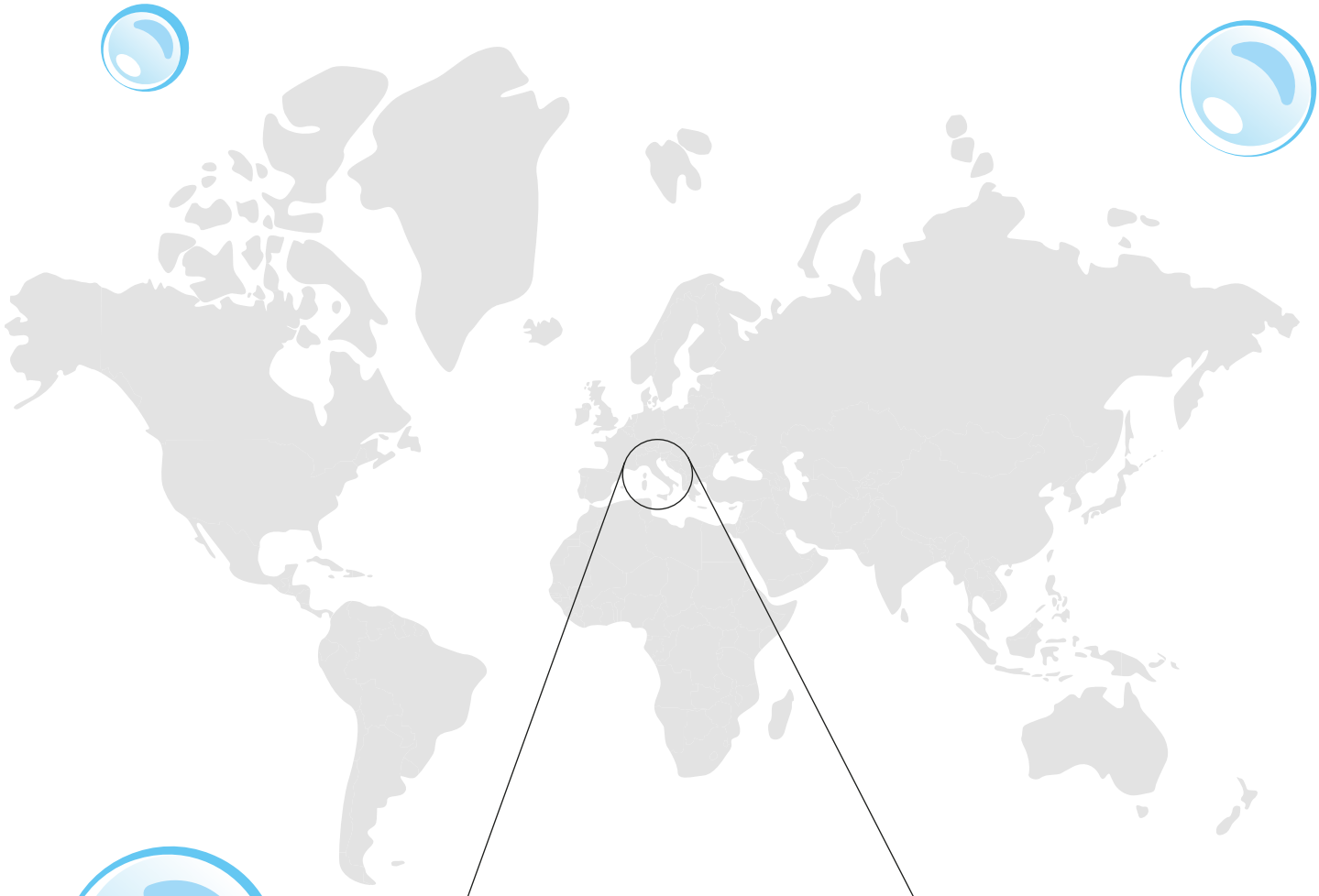

Dulcop International S.p.A.  
via Idice 2/a, 40068 San Lazzaro di Savena (Bologna), Italy  
via Lombardia 48, 40024 Castel San Pietro Terme (Bologna), Italy  
tel: +39 051 625 0711 • corporate e-mail: [info@dulcop.com](mailto:info@dulcop.com)